

WATER QUALITY TRADING PLAN

Waukesha County, Wisconsin

Revised: February 11, 2025

Prepared By: Waukesha County Land Resources Division

Project located in TaxKey BR C1062990001, City of Brookfield

TABLE OF CONTENTS

I.	Executive Summary _____	1
II.	Background _____	3
III.	Location and Description of Credit Generation Sites _____	6
IV.	Methods for Nonpoint Source Load Reductions _____	9
V.	Trade Timeline _____	13
VI.	Inspection and Reporting _____	14
VII.	Certification _____	16

Attachments

- 1) Notice of Intent to Conduct Water Quality Trading
- 2) Water Quality Trading Checklist
- 3) Waukesha County Location Map
- 4) HUC-12 Watershed Map
- 5) Plan Sheets
- 6) Current State of Eroding Streambanks Documentation
- 7) Soils Map and Testing Data
- 8) NRCS Streambank Erosion Model Report
- 9) Operation and Maintenance (O&M) Plan

I. Executive Summary -

This Water Quality Trading Plan summarizes Waukesha County’s (County) plan to utilize Water Quality Trading (WQT) for compliance with the total phosphorus (TP) and total suspended solids (TSS) limits as provided in the Wisconsin Pollutant Discharge Elimination System (WPDES) Permit #WI-S050075-3.

In the Milwaukee River Total Maximum Daily Load (TMDL), in reachshed MN-11, the County is required to remove an additional 6,714 lbs TSS and 42.3 lbs TP above the existing level of pollutant removal, over the course of the next five-year permit term. On an annual basis the additional required removal is 1,343 lb TSS and 8.5 lbs TP per year.

The County identified potential streambank stabilization locations in TaxKey: BR C1062990001 in the City of Brookfield (City) as a means of meeting the removal requirements. Through a Water Quality Trading Agreement (WQTA), the County will split the resulting credits with the City.

NRCS Streambank Erosion modeling methods were used to calculate the TP and TSS credits that would be generated based on the installation of best management practices (BMPs). These credits will be used to demonstrate compliance with the TP and TSS reductions required in the WPDES Permit and TMDL. Modeling results are provided in Table 1.1, from the NRCS calculator.

Table 1.1 – Modeling Results

Pollutant	Bank Length (ft)	Geomean Recession* Rate (ft/yr)	Current Loading (lbs/yr)	Proposed Loading (lbs/yr)	Proposed Reductions (lbs/yr)	Trade Ratio	Proposed Credits** (lb/yr)
TP	255	0.23 – 0.47	19.9	0	19.9	2:1	9.9
TSS	255	0.23 – 0.47	10,146	0	10,146	2:1	5,073

* Based on air photo review at three locations

** Total credits, to be divided by County and City

Justification for Trade Ratio is provided below:

Trade Ratio = (Delivery + Downstream + Equivalency + Uncertainty – Habitat Adjustment):1

- Delivery = 0 (Trading within same HUC-12 Watershed)
- Downstream = 0 (BMP is on the stream reach)
- Equivalency = 0 per guidance (Forms of pollutant not different between MS4 discharge and BMP)
- Uncertainty = 2. *Streambank Stabilization with Habitat Restoration is proposed* (Menomonee River is eligible for habitat restoration since it is classified as an impaired water)

In the WQTA the County would receive half of the credits in Table 1.1, with the other half going to the City. The TP credit of 5.0 lb/yr does not meet the total required reduction of 8.5 lb/yr, but does satisfy the minimum progress reduction of 20% per permit cycle for the next three permit cycles. The TSS credit of 2,036 lb/yr meets the requirement of 1,343 lb/yr. The implementation of this WQT Plan will result in compliance with the TP and TSS load reduction

requirements in Reachshed MN-11.

II. Background -

The purpose of this Water Quality Trading Plan (Plan) is to describe the County's use of Water Quality Trading to comply with the TP and TSS limits as provided in County's WPDES Permit # WI-S050075-3. The Plan was developed following the Notice of Intent to Conduct Water Quality Trading, provided in Attachment #1. The Water Quality Trading Checklist Form 3400-208 is provided in Attachment #2.

Waukesha County is located in southeast Wisconsin. In the Milwaukee River TMDL area the County's municipal separate storm sewer system (MS4) consists entirely of county highways. In the TMDL area, the County MS4 lies in reachsheds MN-1, -6, -7, -8, -10, -11, and -12.

In reachshed MN-11, the County is required to remove an additional 6,714 lbs TSS and 42.3 lbs TP above the existing level of pollutant removal, over the course of the next five-year permit term. On an annual basis the additional required removal is 1,343 lb TSS and 8.5 lbs TP per year.

Various best management practices (BMPs) were evaluated for feasibility, ability to meet the required reductions, and cost-effectiveness, including additional street sweeping, and basin construction of different types and locations. Because of the linear nature of the highway system, meeting the pollutant removal requirements via basin construction would have required construction of numerous BMPs.

As the watershed is highly developed, land acquisition would have been costly. Increased street sweeping could not provide sufficient reductions to meet the requirements. There is no agricultural land in the reachshed. Adaptive management is not available for non-wastewater treatment facilities. Streambank stabilization was selected as combining the best feasibility, effectiveness and cost.

A review was conducted of all streambanks in and upstream of the reachshed to evaluate bank erosion rates, accessibility, and ownership. Privately-owned properties were eliminated due to issues with access. Waukesha County does not own any streambanks in the reachshed.

One streambank locations in City of Brookfield-owned land was identified as being accessible and having measurable bank erosion rates. One of these locations is adjacent to Pomona Road and consists of multiple meanders of the Underwood Creek.

The City of Brookfield was contacted, and a Water Quality Trading Agreement was signed, in which the County and City would share the TP and TSS removal credits generated by the streambank stabilization project. Therefore, after applying the trade ratio and dividing the result by 2, the County's credit would be $\frac{1}{4}$ of the calculated load reduction.

Following the initial watershed investigation, the County elected to move forward with WQT. The County intends to perform WQT projects within the County's HUC-12 # 040400030404 as provided in Attachment #5. The ARPA program is the source of the WQT funding.

WinSLAMM modeling was utilized to determine credits needed. The results of the modeling are summarized in the following table:

Table 2.1 – Pollutant Removal Requirements

	Total Suspended Solids	Total Phosphorus
Modeled, no control (lbs)*	68,070	474
Modeled, with controls (lbs)*	25,879	218
Required Removal %	72.0	62.7
Model % Reduction	62.0	54.0
Deficit (lbs) – five years	6,714	42.3
Deficit (lbs) – annual	1,343	8.5
Reduction needed from project (lbs)**	5,372	34
Proposed annual reduction (lbs)	10,146	19.9

Notes: * Over Five-Year Permit Cycle

** County MN-11 annual deficit x 2 for sharing with City and x 2 for trade ratio. Permit cycle progress requirement is 20% of this number

The goal is to exceed the minimum 20% progress requirement at a minimum, and meet the full requirement if possible.

To generate the required credits, the County intends to perform streambank stabilization. Streambank stabilization will utilize grading and a boulder toe to prevent the erosion of sediment from the streambanks. Streambank stabilization will not only prevent sediment from entering the stream, but will also prevent phosphorus, nitrogen, and other pollutants from discharging to the Menomonee River via Underwood Creek. Reducing pollutant discharge will restore stream habitat and generate water quality trading credits.

III. Location and Description of Credit Generation Site –

The County MS4 within reachshed MN-11 discharges to the Menomonee River via Underwood Creek. As mentioned previously, the County intends to perform WQT projects within the County’s HUC-12 #040400030404. The County plans to implement BMPs to generate TP and TSS credits. Specifically, Streambank stabilization is planned along the banks of Underwood Creek in the City of Brookfield property adjacent to Pomona Road, TaxKey: BR C1062990001. See Figure 3.1 and Figure 3.2 for additional project location information.

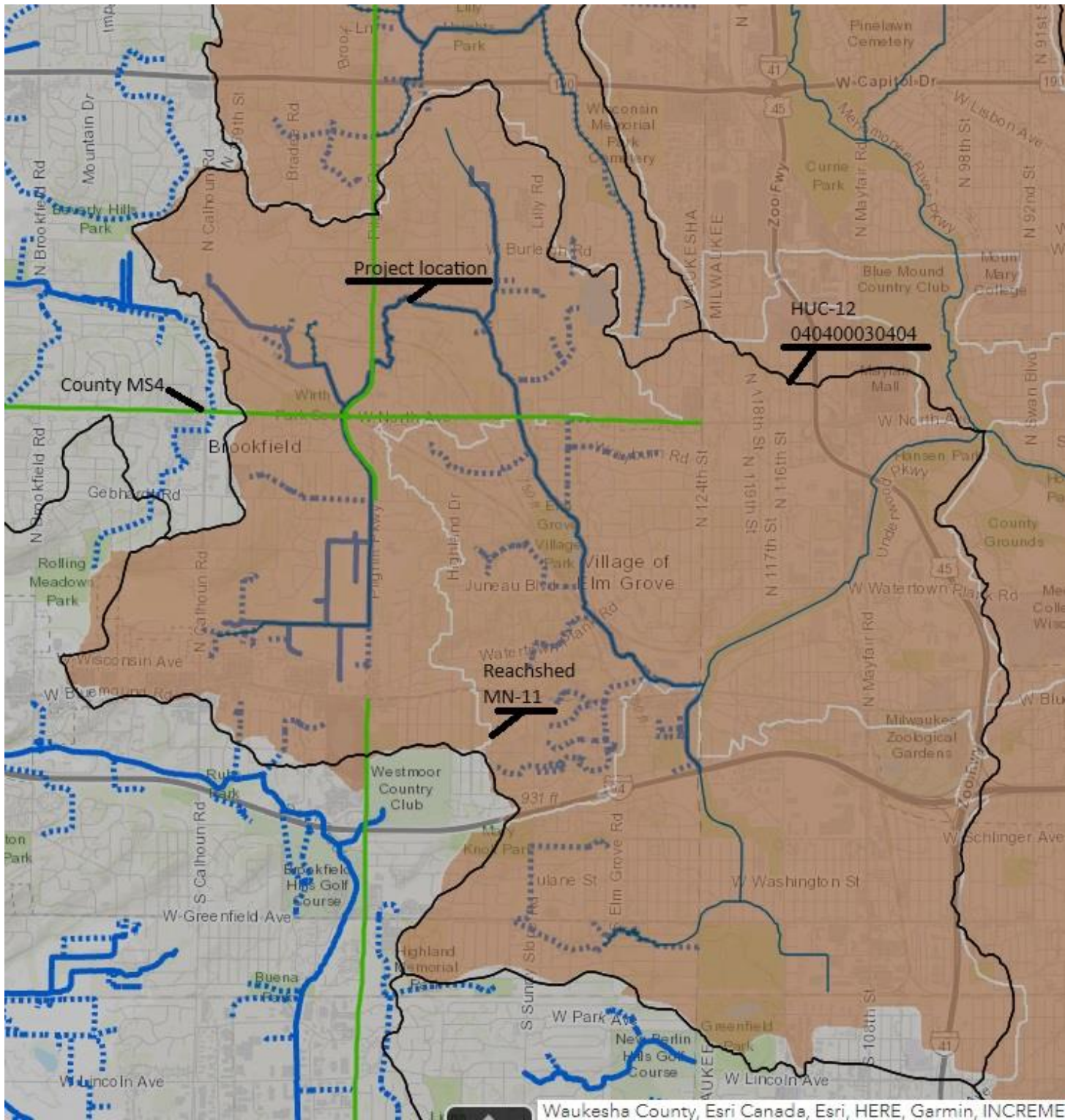

Figure 3.1 – Streambank stabilization location in relation to reached and HUC 12.

IV. Methods for Nonpoint Source Load Reduction –

The County would like to acquire at least 1,343 TSS and 8.5 TP WQT trading credits on an annual basis to meet its pollutant load reduction requirements within reachshed MN-11. The Plan identifies trading practices that will reduce annual TSS and TP runoff by 12,133 lbs and 23.4 lbs, respectively, before application of a 2:1 trade ratio and sharing with the City.

The WQT practices identified for this Water Quality Trading Plan meet 200% of the long-term TSS removal requirement and 59% of the long-term TP removal requirement as long as trading practices are maintained.

A. Methods Used to Generate Load Reductions

For streambank stabilization, County plans to generate TP load reductions through streambank grading with a boulder toe as needed for 255 feet of streambank. Streambank Stabilization will be performed as per NR 328 *Shore Erosion Control Structures in Navigable Waterways*, NRCS 580 *Streambank and Shoreline Protection*, and NRCS 395 *Stream Habitat Improvement and Management*.

Protecting the streambank in high energy locations with wood will better protect the streambank as compared to grading alone. The streambank stabilization project will occur within HUC-12 #040400030404 in order to generate TP and TSS credits. A Plan of the grading and wood protection implementation is provided in Attachment #6.

The County is contracted with Emmons and Olivier Resources, Inc. to design the BMPs and prepare the plans, specification, and operation and maintenance manual. The County will acquire all required permits and authorizations prior to construction. The County will advertise the project for public bidding in the fall of 2024, execute contracts in December of 2024 for construction in 2025. To register credits, the County has entered into a trade agreement with the City of Brookfield pursuant to s. 283.84(1)(b), *Wis. Stats.*

B. History of Project Site

Brookfield is located within the Southern Lake Michigan Coastal ecological landscape. The City was settled in the 1830s and has undergone significant development.

Currently, the land use within the watershed is a mix of commercial, residential, and undeveloped. The commercial and residential areas consist of manicured lawns, impermeable surfaces, and storm sewer. The undeveloped areas typically consist of forest, wetland, and savannah ecosystems. Existing trees are primarily boxelder, willow, and cottonwood.

The streambanks have experienced significant erosion as the Underwood Creek Watershed has been developed and cleared for agricultural and residential use. The banks are predominately undercut with some rills and vegetative overhang. Tree roots are readily visible throughout the reaches. Fallen trees and slumps are also visible in areas.

Recession rates for each Reach along with documentation regarding existing condition

were estimated in Attachment #7. The project area is mapped as floodplain and wetland. The project site was cropped and then left untilled for several years prior to development of the surrounding subdivision in 1969.

C. Model Used to Derive Load Reductions

NRCS Streambank Erosion modeling methods were used to calculate the total phosphorus credits that would be generated based on the installation of BMPs. These credits will be used to demonstrate compliance with the final TP and TSS limits as proposed in the WPDES Permit. Modeling results are provided in Table 4.1.

Table 4.1 – Modeling Results

Pollutant	Bank Length (ft)	Geomean Recession* Rate (ft/yr)	Current Loading (lbs/yr)	Proposed Loading (lbs/yr)	Proposed Reductions (lbs/yr)	Trade Ratio	Proposed Credits** (lb/yr)
TP	255	0.23 – 0.47	19.9	0	19.9	2:1	9.9
TSS	255	0.23 – 0.47	10,146	0	10,146	2:1	5,073

* Based on air photo review at three locations

** Total credits, to be divided by County and City

Justification for Trade Ratio is provided below:

Trade Ratio = (Delivery + Downstream + Equivalency + Uncertainty – Habitat Adjustment):1

- Delivery = 0 (Trading within same HUC-12 Watershed)
- Downstream = 0 (All Trades are upstream of the Outfall 001)
- Equivalency = 0 (Not necessary of Total Phosphorus)
- Uncertainty:
Streambank Stabilization with Habitat Restoration = 2 (Menomonee River is eligible for habitat restoration since it is classified as an impaired water)

Soil testing has been completed to determine TP concentrations and particle size distributions within the soil. Soil sampling was performed every 30 feet and included the use of a trowel which pulled one core at each location to a 4” depth. The samples were combined and mixed to create a single composite sample. Soils maps and soil testing data is provided in Attachment #8. Soil sample locations are provided in Attachment #6. An evaluation using historic air photos and field observations and measurements has been conducted to estimate stream bank recession rate. The streambank has also been surveyed horizontally and vertically via Global Position System (GPS) Equipment. The survey data, narrative, and photos documenting the current state of eroding stream banks is provided in Attachment #7.

With the collected data, the NRCS Streambank Erosion Model was used to calculate TP and TSS loss from each reach of the eroding streambank. The modeling data for the NRCS Streambank Erosion Model is available in Attachment #9. The designed streambank stabilization grading and toe wood will eliminate streambank recession

thus eliminating pollutant inputs due to streambank recession in planned areas. For the Habitat Restoration portions of the WQT Plan, the County has been in contact with the DNR Fisheries Biologist for Waukesha County for direction regarding stream habitat improvements. The County will submit the final design plans and specifications to the DNR for approval. Pollutant reduction Credits will be registered following construction of the BMPs.

If the Plan or model inputs change, the County will submit to the DNR the revised models and calculations to more accurately reflect the number of credits generated.

D. Stream Habitat Improvements

As provided in NRCS 395 Stream Habitat Improvement and Management, the definition of *stream habitat improvement and management* is to maintain, improve physical, chemical, and biological functions of a stream, and its associated riparian zone, necessary for meeting the life history and requirements of desired aquatic species. The goal of stream habitat improvements within this Plan is to provide suitable habitat for desired fish and other aquatic species as well as provide riparian condition that maintain the stream corridor ecological processes which supports diverse stream habitat and aquatic species.

Prior to designing stream habitat improvements, the current conditions of Underwood Creek and surrounding land uses were evaluated. The Underwood Creek watershed is dominated by urban development. Underwood Creek experiences significant storm water runoff issues including flooding, increased bank erosion, sedimentation, and limited riparian habitat. This is primarily caused by residential and commercial development within the watershed. Underwood Creek is listed on State of Wisconsin 2018 Impaired Waters List due to total phosphorus, total suspended solids, chloride, and bacteria.

Underwood Creek is a cool-warm mainstem aquatic community. Limited fishing opportunities are available on Underwood Creek. Underwood Creek is comprised primarily of silt substrates. Pools are scarce throughout.

The proposed habitat improvement is a total of eight rock wing deflectors, designed to create pools and to direct flow into the center of the thalweg.

E. Operation and Maintenance

An Operation and Maintenance (O&M) Plan is provided in Attachment #9. The O&M plan describes in how the Stream Stabilization Practices will be operated and maintained. The O&M Plan also addresses response procedures for Practice Registration, Noncompliance Notification, and Notification of Trade Agreement Termination.

As previously mentioned, the County is planning to perform streambank stabilization by installing a boulder toe and wing deflectors along approximately 255 feet of streambank. The stabilization practices will be installed and maintained as per NR 328 *Shore Erosion Control Structures in Navigable Waterways*, NRCS 580 *Streambank and Shoreline Protection*, and NRCS 395 *Stream Habitat Improvement and Management*. Restoration landscaping and seeding will be installed following construction and will be closely monitored for a minimum of two (2) growing seasons

to ensure the new seeding grows and erosion is not prevalent. The County will also address weed and invasive vegetation growth if present during the duration of the permit. The boulder toe will be inspected following heavy rain events at a minimum. Inspection will be used to determine appropriate actions in order to maintain the toe wood for continuous and ongoing streambank stabilization and pollutant reduction credit generation. Following project completion, the City of Brookfield will be responsible for ongoing maintenance.

The BMPs will be inspected annually by a licensed Professional Engineer to ensure that the BMPs are functioning as intended in order to meet the requirements of this WQT Plan.

V. Trade Timeline –

Schedule for Installation of the above-mentioned trading practices for pollutant reduction Credit Generation for TP and TSS compliance is provided in Table 5.1 below.

Table 5.1 – Trade Timeline

Item	Completion Date
Site Investigation	October 15, 2023
Conceptual Design	November 30, 2023
Final Design	June 30, 2024
Construction Permits	September 30, 2024
DNR Review of Final Design	November 30, 2024
Construction of BMPs	Summer 2025
Phosphorus Credit Registration	September 7, 2025
Use of Phosphorus Credits by Waukesha County (Ongoing for Permit Compliance)	September 7, 2025

The County has been in contact with the DNR Water Regulation & Zoning Senior Specialist for Waukesha County who has provided guidance for required permits for the WQT Plan. Waterway and wetland permit applications have been submitted via WAMS.

At this time, no permitting issues have arisen to hinder the Project Progress. Credits will be used by the County beginning 9/7/2025. Credits will continue as long as the trading practices are maintained as outlined in this WQT Plan.

VI. Inspection Reporting –

A. Tracking Procedures

The County will track credits used annually. The County will report credit usage to the DNR on an annual basis in the MS4 Annual Reports. The annual report will summarize the 12 months of credit usage and credit generation. The County will report to DNR any concern that they have that may result in a need to modify the trade agreement and/or this trade plan. For example, a need to generate additional credits based on discharge.

B. Inspection

Inspection of the BMPs shall occur during construction phase to ensure they are installed per the design and meet all applicable codes and permits. Once completed, inspections of the established BMPs shall occur each month at a minimum or following heavy rain events. A licensed professional engineer will perform an annual certification to ensure the practice is performing as designed and the County remains in compliance.

The inspection reports will include:

- i. Name and contact information of the inspector
- ii. Inspection Date
- iii. Relevant standards set forth in the Design Plan or Operation and Maintenance Plan
- iv. Issues identified
- v. When and how any issues identified were addressed
- vi. When and how any issues identified will be addressed in the future

Inspection reports generated during each routine or after rain event inspection will be included with the Annual Water Quality Trading Report submitted by the County to DNR and the City of Brookfield. Annual inspections by a professional engineer will typically occur in April or May. This time of year is ideal for evaluating the condition of BMPs as it follows the freeze/thaw which poses the greatest potential for changes to the BMPs. Minimal vegetation cover will allow for adequate visual inspection.

C. Management Practice Registration Form

The County will file a completed registration form 3400-207 for Water Quality Trading Management Practice Registration separately from this Plan.

D. Annual Water Quality Trading Report Submittal

The following shall be submitted to the DNR by January 31 of each year:

- i. The number of pollutant reduction credits (lbs/month) used each month of the previous year to demonstrate compliance;
- ii. A summary of the annual inspection of the practice that generated any of the pollutant reduction credits used during the previous year, this inspection shall be completed by a licensed Professional Engineer;
- iii. All monthly inspection reports;

- iv. Identification of noncompliance or failure to implement any terms or conditions of this permit with respect to water quality trading that have not been reported in discharge monitoring reports;
- v. A list of all noncompliance and the correction measures and timing to address the issues throughout the year; and
- vi. An updated WQT plan if management practices have or will change.

E. Annual Certification of Management Practices

Each year, the County will certify that the BMPs are maintained and operating in a manner consistent with this Water Quality Trading Plan or provide a statement noting noncompliance with this Plan. The annual MS4 Report will include the following statement as a certification of compliance when the Credit Generating Practice is operating in a manner consistent with the Plan:

“I certify that to the best of my knowledge that the management practices identified in the approved water quality trading plan as the source of pollutant removal credits is installed, established and properly maintained.”

F. Notification of Failure to Generate Credits

The County will notify DNR by telephone call to DNR’s regional storm water municipal permitting and compliance staff within 24 hours or next business day of becoming aware that pollutant removal credits used or intended for use by County are not being generated as outlined in this Water Quality Trading Plan.

The County will submit a written notification within five days after the County recognizes that the pollutant removal credits are not being generated as outlined in the Trading Plan. DNR may waive the requirement for submittal for a written notice within five days and instruct the County to submit the written notice with the next regularly scheduled monitoring report required by County’s WPDES Permit.

The written notice will contain a description of how and why the pollutant removal credits are not being generated as outlined in the Water Quality Trading Plan, the steps taken or planned to prevent reoccurrence of the identified problems and the length of time anticipated it will take to address the issue.

The County will work to rectify the problem as laid out in the Operation and Maintenance Plans.

G. Conditions under which Management Practices May Be Inspected

Any DNR authorized officer, employee, or representative has the right to access and inspect the credit generating practice so long as the County’s trade agreement with the property owner(s) and this Water Quality Trading Plan remain in effect.

VII. Certification -

The undersigned hereby certifies that this Water Quality Trading Plan is accurate and correct to the best of his knowledge.

Waukesha County



By: _____

Alan Barrows
Land Resources Manager
Waukesha County Parks and Land Use
Room AC 260 515 W. Moreland Blvd.
Waukesha, WI 53188
Telephone: (262) 896-8307
Email: abarrows@waukeshacounty.gov

Attachment #1

Notice of Intent to Conduct Water Quality Trading
 Form 3400-206 (1/14) Page 1 of 2

Notice: Pursuant to s. 283.84, Wis. Stats., and ch. NR 217 Wis. Adm. Code, this form must be completed by any WPDES permittee that is using water quality trading as a method of complying with a permit limitation. Failure to complete this form would not result in penalties. Personal information collected will be used for administrative purposes and may be provided to requesters to the extent required by Wisconsin's Open Records Law (ss. 19.31 - 19.39, Wis. Stats.).

Applicant Information				
Permittee Name Waukesha County		Permit Number WI- S050075	Facility Site Number 33641	
Facility Address Room AC 260, 515 W. Moreland Blvd.		City Waukesha	State WI	ZIP Code 53066
Project Contact Name (if applicable) Alan Barrows	Address Room AC 260, 515 W. Moreland Blvd	City Waukesha	State WI	ZIP Code 53066
Project Name Streambank stabilization, conservation agriculture				
Receiving Water Name Menomonee River	Parameter(s) being traded Total phosphorus, total suspended solids	HUC 12(s) 0404000304		
Is the permittee in a point or nonpoint source dominated watershed? (See PRESTO results - http://dnr.wi.gov/topic/surfacewater/presto.html) <input type="radio"/> Point source dominated <input checked="" type="radio"/> Nonpoint source dominated				

Credit Generator Information	
Credit generator type (select all that apply):	<input type="checkbox"/> Permitted Discharge (non-MS4/CAFO) <input type="checkbox"/> Urban nonpoint source discharge <input checked="" type="checkbox"/> Permitted MS4 <input type="checkbox"/> Agricultural nonpoint source discharge <input type="checkbox"/> Permitted CAFO <input type="checkbox"/> Other - Specify: _____
Are any of the credit generators in a different HUC 12 than the applicant?	<input type="radio"/> Yes; HUC 12: _____ <input checked="" type="radio"/> No <input type="radio"/> Unsure
Are any of the credit generators downstream of the applicant?	<input type="radio"/> Yes <input checked="" type="radio"/> No <input type="radio"/> Unsure
Will a broker/exchange be used to facilitate trade?	<input type="radio"/> Yes; Name: _____ <input checked="" type="radio"/> No <input type="radio"/> Unsure

Point to Point Trades (Traditional Municipal / Industrial Discharge, MS4, CAFO)				
Discharge Type	Permit Number	Name	Contact Address	Is the point source credit generator currently in compliance with their permit requirements?
<input type="radio"/> Traditional <input type="radio"/> MS4 <input type="radio"/> CAFO				<input type="radio"/> Yes <input type="radio"/> No <input type="radio"/> Unsure
<input type="radio"/> Traditional <input type="radio"/> MS4 <input type="radio"/> CAFO				<input type="radio"/> Yes <input type="radio"/> No <input type="radio"/> Unsure
<input type="radio"/> Traditional <input type="radio"/> MS4 <input type="radio"/> CAFO				<input type="radio"/> Yes <input type="radio"/> No <input type="radio"/> Unsure
<input type="radio"/> Traditional <input checked="" type="radio"/> MS4 <input type="radio"/> CAFO	WI-S065404	City of Brookfield	Theresa Caven 2000 N Calhoun Rd Brookfield, WI 53005	<input type="radio"/> Yes <input type="radio"/> No <input checked="" type="radio"/> Unsure
<input type="radio"/> Traditional <input type="radio"/> MS4 <input type="radio"/> CAFO				<input type="radio"/> Yes <input type="radio"/> No <input type="radio"/> Unsure

Notice of Intent to Conduct Water Quality Trading

Form 3400-206 (1/14)

Page 2 of 2

Point to Nonpoint Trades (Non-permitted Agricultural, Non-Permitted Urban, etc.)

List the practices that will be used to generate credits:

Streambank stabilization in Underwood Creek near Pomona Rd. Practice location is in reachshed MN-11. Credits will be applied by Waukesha County in MN-11 and MN-12, which is downstream. See attached map and table.

Method for quantifying credits generated: Monitoring
 Modeling, Names: NRCS tool, SPARROW
 Other: _____

Projected date credits will be available: 07/18/2025

The preparer certifies all of the following:

- I am familiar with the specifications submitted for this application, and I believe all applicable items in this checklist have been addressed.
- I have completed this document to the best of my knowledge and have not excluded pertinent information.

Signature of Preparer  Date Signed 5-24-23

Authorized Representative Signature

I certify under penalty of law that this document and all attachments were prepared under my direction or supervision. Based on my inquiry of those persons directly responsible for gathering and entering the information, the information is, to the best of my knowledge and belief, accurate and complete. I am aware that there are significant penalties for submitting false information, including the possibility of fine and imprisonment for knowing violations.

Signature of Authorized Representative  Date Signed 5/24/23

Attachment #2

Notice: Pursuant to s. 283.84, Wis. Stats., this form must be completed by any WPDES permittee that intends to pursue pollutant trading as a method of complying with a permit limitation. Failure to complete this form would not result in penalties. Personal information collected will be used for administrative purposes and may be provided to requesters to the extent required by Wisconsin's Open Records Law (ss. 19.31 - 19.39, Wis. Stats.).

Applicant Information

Permittee Name Waukesha County		Permit Number WI- S050075-3	Facility Site Number 33641	
Facility Address 515 W. Moreland Blvd.		City Waukesha	State WI	ZIP Code 53188
Project Contact Name (if applicable) Alan Barrows	Address Room AC 260, 515. W Moreland Blvd	City Waukesha	State WI	ZIP Code 53188
Project Name Rotary Park Streambank Stabilization				
Receiving Water Name Menomonee River	Parameter(s) being traded Total phosphorus, total suspended solids	HUC 12(s) 040400030403		

Credit Generator Information

Credit generator type (select all that apply):

<input type="checkbox"/> Permitted Discharge (non-MS4CAFO)	<input type="checkbox"/> Urban nonpoint source discharge
<input checked="" type="checkbox"/> Permitted MS4	<input type="checkbox"/> Agricultural nonpoint source discharge
<input type="checkbox"/> Permitted CAFO	<input type="checkbox"/> Other - Specify: _____

Are any of the credit generators in a different HUC 12 than the applicant? Yes; HUC 12: _____
 No

Are any of the credit generators downstream of the applicant? Yes
 No

Will a broker/exchange be used to facilitate trade? Yes (include description and contact information in WQT plan)
 No

Point to Point Trades (Traditional Municipal / Industrial, MS4, CAFO)

Are each of the point source credit generators identified in this section in compliance with their WPDES permit requirements? Yes
 No

Discharge Type	Permit Number	Name	Contact Information	Trade Agreement Number
<input type="radio"/> Traditional <input checked="" type="radio"/> MS4 <input type="radio"/> CAFO	WI-S065404	City of Brookfield	Theresa Caven, 2000 N Calhoun Rd, Brookfield	WC3
<input type="radio"/> Traditional <input type="radio"/> MS4 <input type="radio"/> CAFO				
<input type="radio"/> Traditional <input type="radio"/> MS4 <input type="radio"/> CAFO				
<input type="radio"/> Traditional <input type="radio"/> MS4 <input type="radio"/> CAFO				
<input type="radio"/> Traditional <input type="radio"/> MS4 <input type="radio"/> CAFO				

Water Quality Trading Checklist

Form 3400-208 (1/14)

Page 2 of 3

Point to Point Trades (Traditional Municipal / Industrial, MS4, CAFO) *cont.*

Does plan have a narrative that describes:	Plan Section
a. Summary of discharge and existing treatment including optimization <input checked="" type="radio"/> Yes <input type="radio"/> No	I
b. Amount of credit being generated <input checked="" type="radio"/> Yes <input type="radio"/> No	I
c. Timeline for credits and agreements <input checked="" type="radio"/> Yes <input type="radio"/> No	V
d. Method for quantifying credits <input checked="" type="radio"/> Yes <input type="radio"/> No	IV
e. Tracking and verification procedures <input checked="" type="radio"/> Yes <input type="radio"/> No	VI
f. Location of credit generator in proximity to receiving water and credit user <input checked="" type="radio"/> Yes <input type="radio"/> No	III
g. Other: _____ <input type="radio"/> Yes <input type="radio"/> No	

Point to Nonpoint Trades (Non-Permitted Urban, Agricultural, Other)

Discharge Type	Practices Used to Generate Credits	Method of Quantification	Trade Agreement Number	Have the practice(s) been formally registered?
<input type="radio"/> Urban NPS <input type="radio"/> Agricultural NPS <input type="radio"/> Other				<input type="radio"/> Yes <input type="radio"/> No <input type="radio"/> Only in part
<input type="radio"/> Urban NPS <input type="radio"/> Agricultural NPS <input type="radio"/> Other				<input type="radio"/> Yes <input type="radio"/> No <input type="radio"/> Only in part
<input type="radio"/> Urban NPS <input type="radio"/> Agricultural NPS <input type="radio"/> Other				<input type="radio"/> Yes <input type="radio"/> No <input type="radio"/> Only in part
<input type="radio"/> Urban NPS <input type="radio"/> Agricultural NPS <input type="radio"/> Other				<input type="radio"/> Yes <input type="radio"/> No <input type="radio"/> Only in part
<input type="radio"/> Urban NPS <input type="radio"/> Agricultural NPS <input type="radio"/> Other				<input type="radio"/> Yes <input type="radio"/> No <input type="radio"/> Only in part
<input type="radio"/> Urban NPS <input type="radio"/> Agricultural NPS <input type="radio"/> Other				<input type="radio"/> Yes <input type="radio"/> No <input type="radio"/> Only in part
<input type="radio"/> Urban NPS <input type="radio"/> Agricultural NPS <input type="radio"/> Other				<input type="radio"/> Yes <input type="radio"/> No <input type="radio"/> Only in part
<input type="radio"/> Urban NPS <input type="radio"/> Agricultural NPS <input type="radio"/> Other				<input type="radio"/> Yes <input type="radio"/> No <input type="radio"/> Only in part

Does plan have a narrative that describes:	Plan Section
a. Description of existing land uses <input type="radio"/> Yes <input type="radio"/> No	
b. Management practices used to generate credits <input type="radio"/> Yes <input type="radio"/> No	
c. Amount of credit being generated <input type="radio"/> Yes <input type="radio"/> No	
d. Description of applicable trade ratio per agreement/management practice <input type="radio"/> Yes <input type="radio"/> No	
e. Location where credits will be generated <input type="radio"/> Yes <input type="radio"/> No	
f. Timeline for credits and agreements <input type="radio"/> Yes <input type="radio"/> No	
g. Method for quantifying credits <input type="radio"/> Yes <input type="radio"/> No	

Water Quality Trading Checklist

Form 3400-208 (1/14)

Page 3 of 3

Does plan have a narrative that describes:		Plan Section
h. Tracking procedures	<input type="radio"/> Yes <input type="radio"/> No	
i. Conditions under which the management practices may be inspected	<input type="radio"/> Yes <input type="radio"/> No	
j. Reporting requirements should the management practice fail	<input type="radio"/> Yes <input type="radio"/> No	
k. Operation and maintenance plan for each management practice	<input type="radio"/> Yes <input type="radio"/> No	
l. Location of credit generator in proximity to receiving water and credit user	<input type="radio"/> Yes <input type="radio"/> No	
m. Practice registration documents, if available	<input type="radio"/> Yes <input type="radio"/> No	
n. History of project site(s)	<input type="radio"/> Yes <input type="radio"/> No	
o. Other: _____	<input type="radio"/> Yes <input type="radio"/> No	

The preparer certifies all of the following:

- I am familiar with the specifications submitted for this application, and I believe all applicable items in this checklist have been addressed.
- I have completed this document to the best of my knowledge and have not excluded pertinent information.
- I certify that the information in this document is true to the best of my knowledge.

Signature of Preparer	Date Signed
-----------------------	-------------

Authorized Representative Signature

I certify under penalty of law that this document and all attachments were prepared under my direction or supervision. Based on my inquiry of those persons directly responsible for gathering and entering the information, the information is, to the best of my knowledge and belief, accurate and complete. I am aware that there are significant penalties for submitting false information, including the possibility of fine and imprisonment for knowing violations.

Signature of Authorized Representative	Date Signed
--	-------------



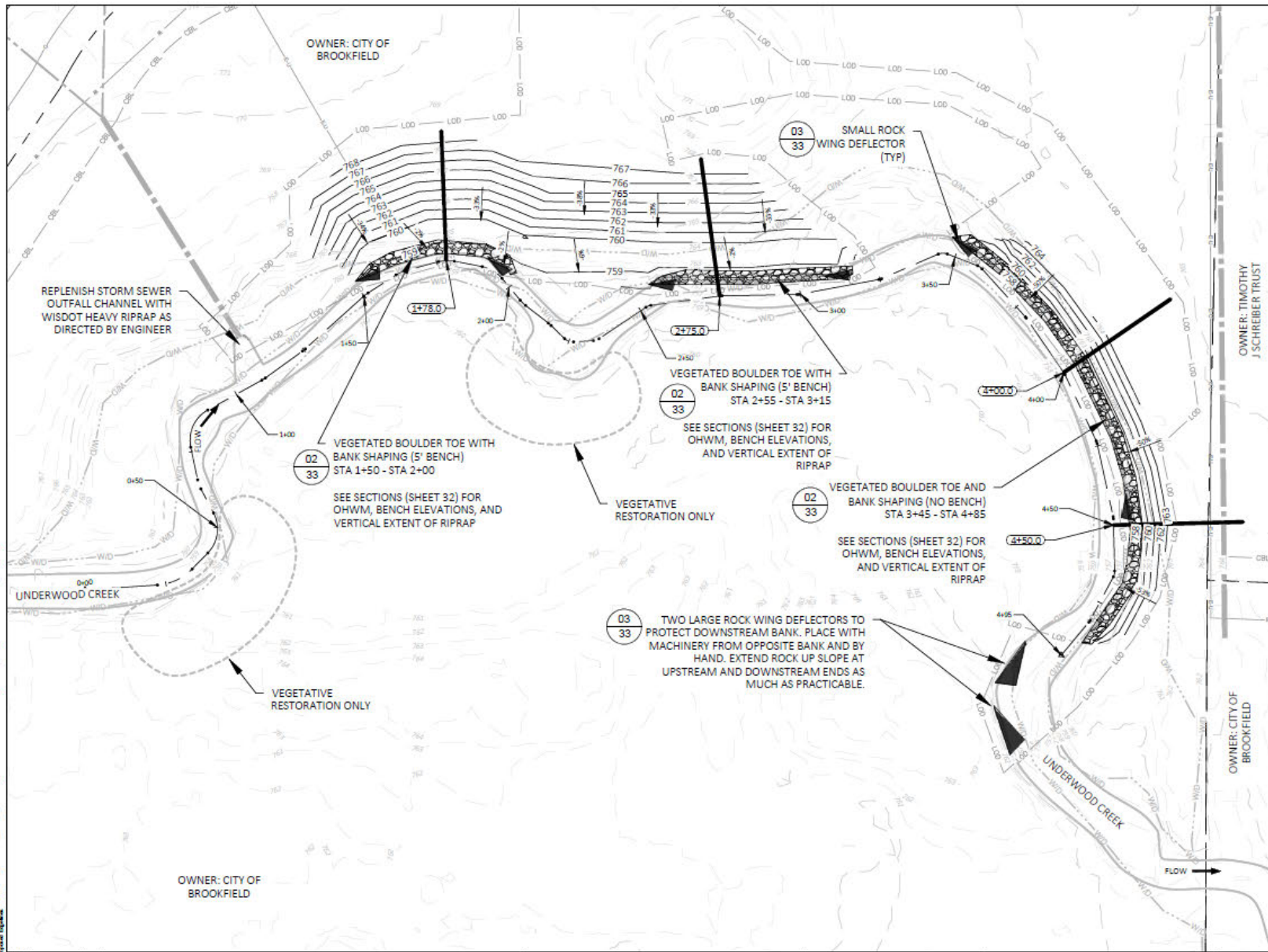



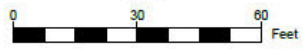

Attachment #3



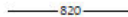
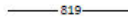



LEGEND

-  PARCEL
-  EXISTING MAJOR CONTOUR
-  EXISTING MINOR CONTOUR
-  PROPOSED MAJOR CONTOUR
-  PROPOSED MINOR CONTOUR
-  LIMITS OF DISTURBANCE
-  DELINEATED WETLAND BOUNDARY
-  SECTION LINE
-  PROPOSED RIPRAP
-  ROCK WING DEFLECTOR (SMALL)
-  ROCK WING DEFLECTOR (LARGE)

5			
4			
3			
2			
1			
0	10/06/2024	NGH	FINAL BID PLAN SET
NO	DATE	BY	REVISION

ISSUE DATE
10/06/2024

DESIGN BY
EOR

DRAWN BY
NGHBP

EOR PROJECT NO.
2024-0001

EOR Emmons & Olivier Resources, Inc.
1334 DEWEY COURT
MADISON, WI 53703
Tel: 808.839.4422
www.eorinc.com

WAUKESHA COUNTY
WATER AND LAND USE
515 W. MORELAND BLVD.,
WAUKESHA, WI 53188

ARPA STORMWATER MANAGEMENT PRACTICES

POMONA ROAD STABILIZATION:
GRADING PLAN

Attachment #4

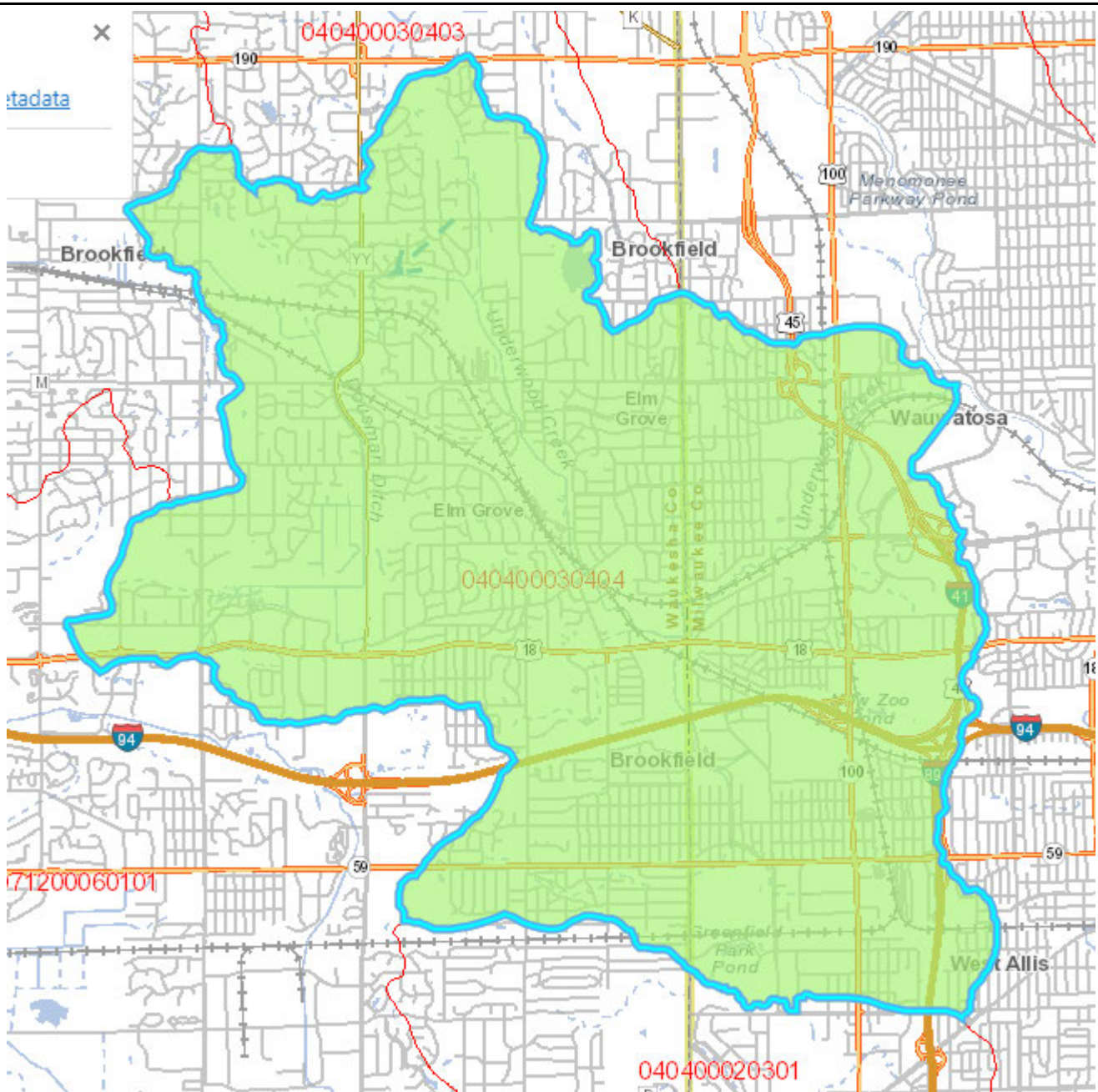

Attachment #5

Location of Reaches A, B, and C



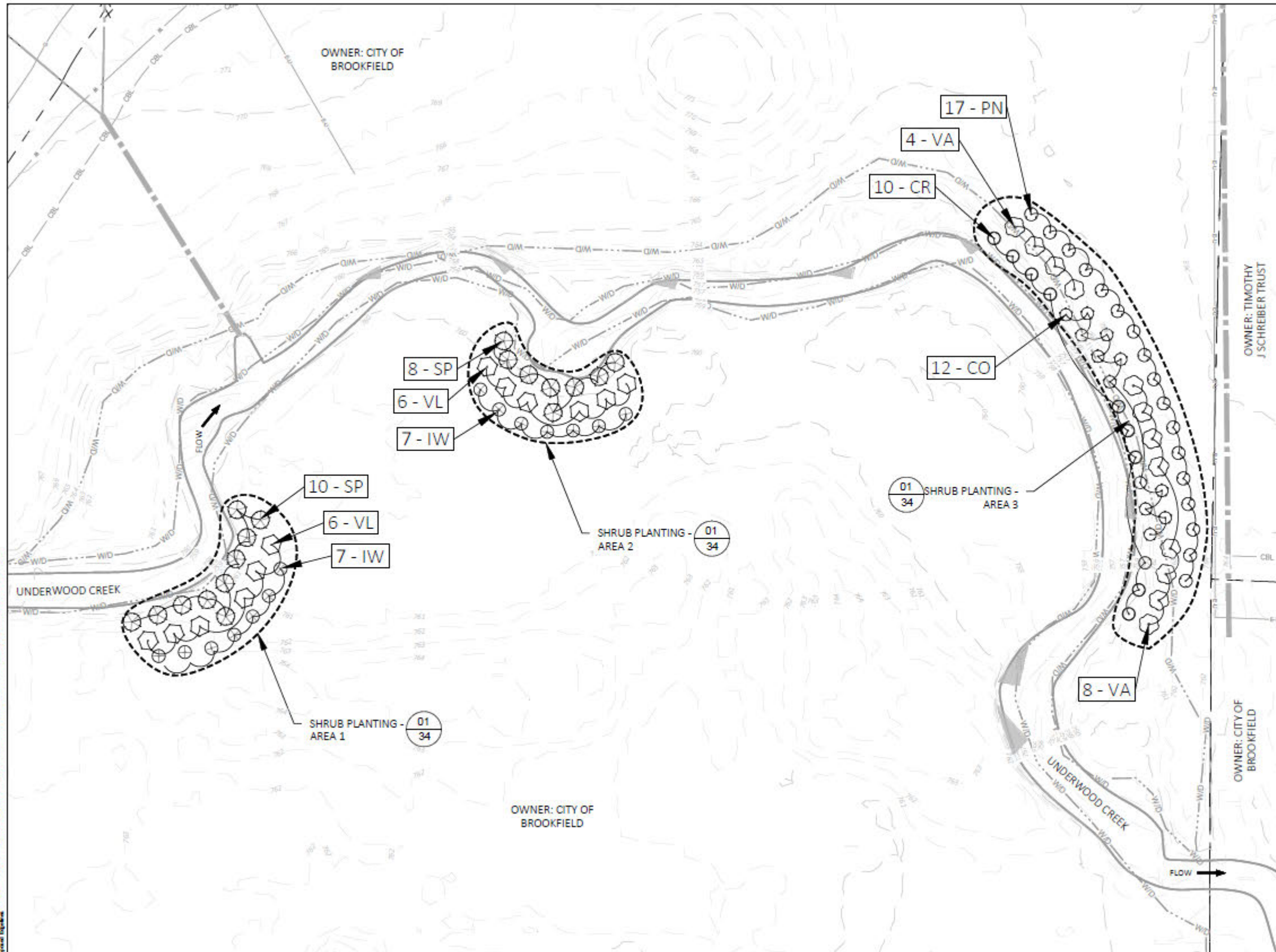

PLANT SCHEDULE - AREA 1

SYMBOL	CODE	BOTANICAL / COMMON NAME	SIZE	TYPE	QTY
SHRUBS					
	W	Ilex verticillata / Winterberry	3 gal.	Cont	7
	SP	Salix discolor / Pussy Willow	3 gal.	Cont	10
	VL	Viburnum lentago / Nannyberry	3 gal.	Cont	6

PLANT SCHEDULE - AREA 2

SYMBOL	CODE	BOTANICAL / COMMON NAME	SIZE	TYPE	QTY
SHRUBS					
	W	Ilex verticillata / Winterberry	3 gal.	Cont	7
	SP	Salix discolor / Pussy Willow	3 gal.	Cont	8
	VL	Viburnum lentago / Nannyberry	3 gal.	Cont	6

PLANT SCHEDULE - AREA 3

SYMBOL	CODE	BOTANICAL / COMMON NAME	SIZE	TYPE	QTY
SHRUBS					
	CO	Cephalanthus occidentalis / Buttonbush	3 gal.	Cont	12
	CR	Cornus sericea / Red Twig Dogwood	3 gal.	Cont	10
	PN	Physocarpus opulifolius / Ninebark	3 gal.	Cont	17
	VA	Viburnum trilobum / American Cranberrybush	3 gal.	Cont	12

5			
4			
3			
2			
1			
0	10/09/2024	NGH	FINAL BID PLAN SET
NO	DATE	BY	REVISION

ISSUE DATE: 10/09/2024
 DESIGN BY: EOR DRAWN BY: NGH/EP
 EOR PROJECT NO.: 2028-0001
Emmons & Olivier Resources, Inc.
 1334 DEWEY COURT
 MADISON, WI 53703
 Tel: 608.839.4422
 www.eorinc.com

WAUKESHA COUNTY
 PLANNING AND LAND USE
 515 W. MORELAND BLVD.
 WAUKESHA, WI 53188

ARPA STORMWATER MANAGEMENT PRACTICES

POMONA ROAD STABILIZATION: PLANTING PLAN

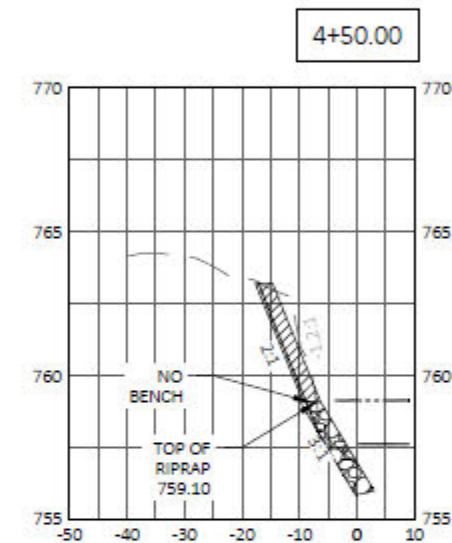
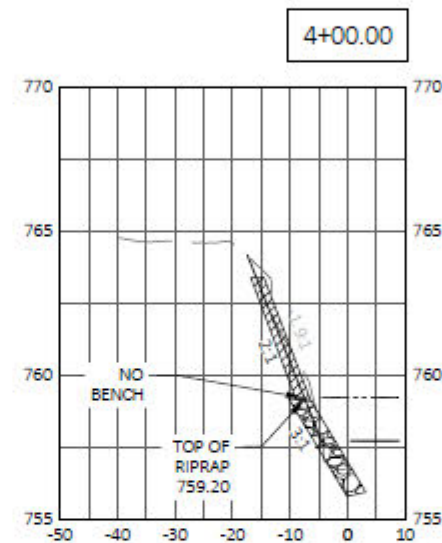
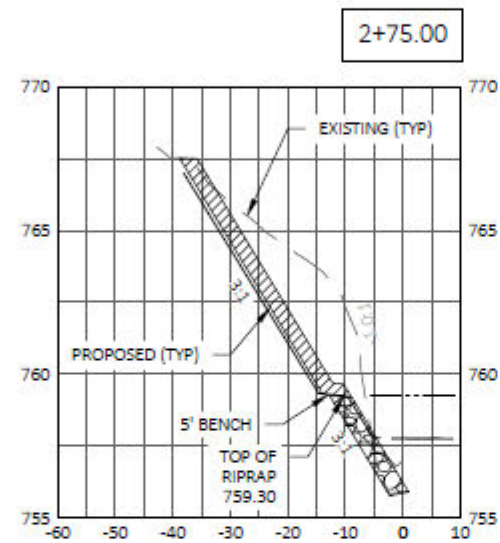
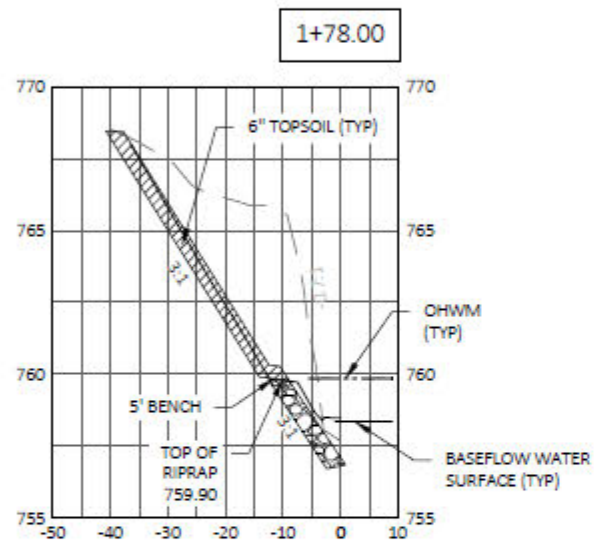

SECTIONS

HORIZONTAL SCALE: 1"=30'
5X VERTICAL EXAGGERATION

5			
4			
3			
2			
1			
0	10/09/2024	NGH	FINAL BID PLAN SET
NO	DATE	BY	REVISION

ISSUE DATE	10/09/2024
DESIGN BY	EOR
DRAWN BY	NGH/BP
EOR PROJECT NO.	2028-0001

EOR Emmons & Olivier Resources, Inc.
1334 DEWEY COURT
MADISON, WI 53703
Tel: 608.839.4422
www.eorinc.com

WAUKESHA COUNTY
WATER
515 W. MORELAND BLVD.,
WAUKESHA, WI 53188

ARPA STORMWATER MANAGEMENT PRACTICES

POMONA ROAD STABILIZATION:
SECTIONS

- NOTES:
- BOULDER MATERIAL SHALL BE WISDOT HEAVY RIPRAP.
 - FILTER MATERIAL SHALL BE WISDOT BACKFILL GRANULAR GRADE 1.

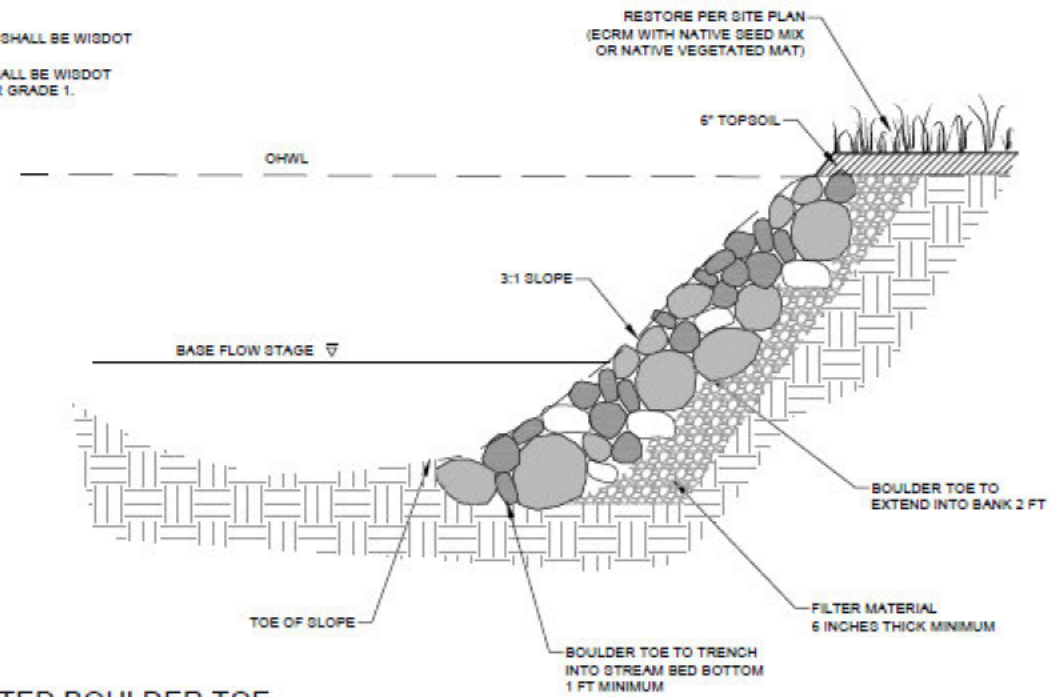

01 VEGETATED BOULDER TOE
33 NOT TO SCALE

- NOTES:
- PROVIDE EROSION CONTROL AND RESTORATION ABOVE OHWL PER PLANS

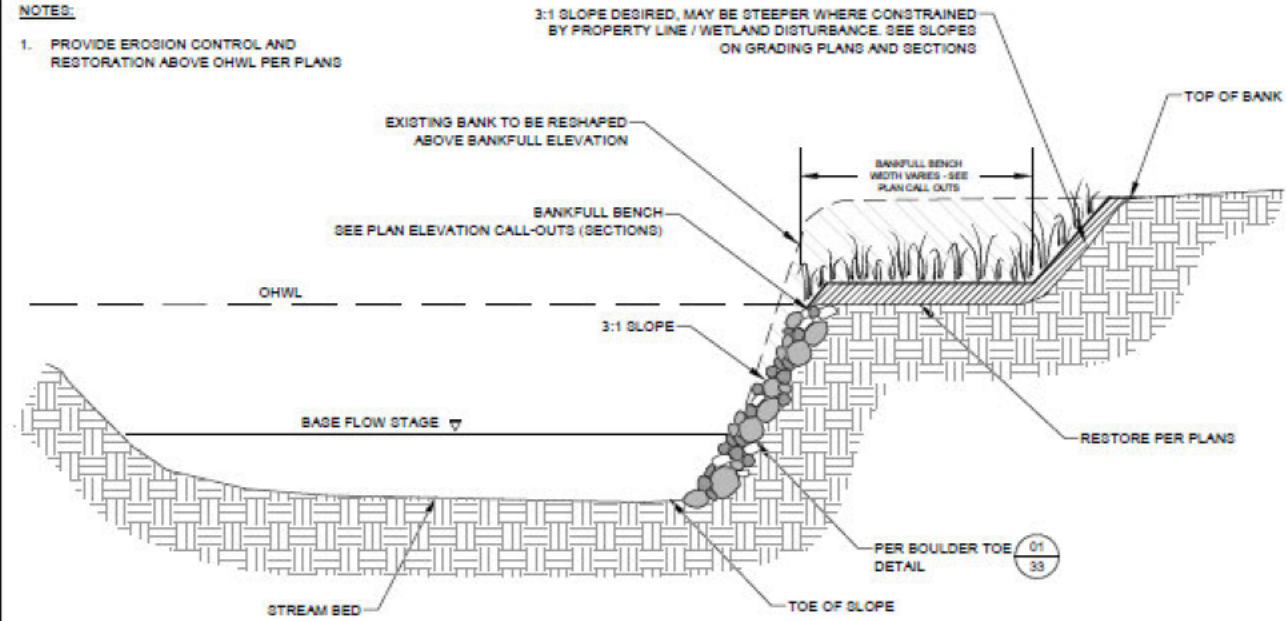

02 VEGETATED BOULDER TOE WITH BANK SHAPING
33 NOT TO SCALE

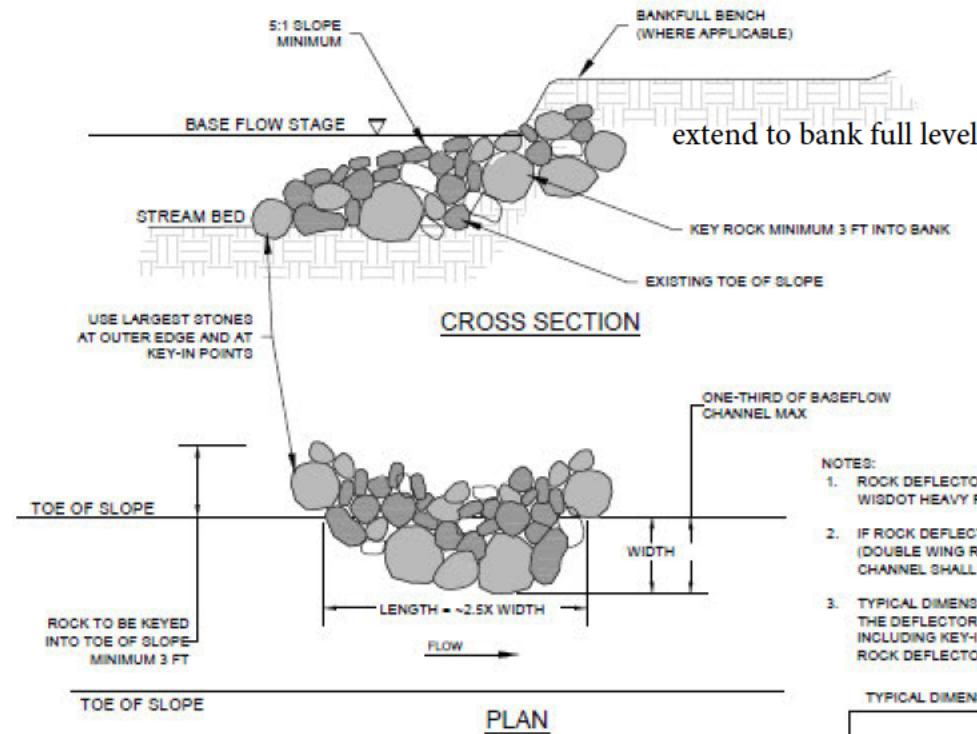

03 ROCK DEFLECTOR
33 NOT TO SCALE

- NOTES:
- ROCK DEFLECTORS SHALL BE CONSTRUCTED USING WISDOT HEAVY RIPRAP (ANGULAR).
 - IF ROCK DEFLECTORS ARE PLACED ON OPPOSITE BANKS (DOUBLE WING ROCK DEFLECTOR), MIDDLE-THIRD OF CHANNEL SHALL BE LEFT COMPLETELY UNOBSTRUCTED.
 - TYPICAL DIMENSIONS FOR THE IN-CHANNEL PORTION OF THE DEFLECTOR, AS WELL AS THE TOTAL STONE VOLUME INCLUDING KEY-IN, IS SHOWN FOR "SMALL" AND "LARGE" ROCK DEFLECTORS, AS SHOWN ON THE PLANS.

TYPICAL DIMENSIONS AND STONE PER DEFLECTOR

SIZE	WIDTH	HEIGHT	LENGTH	TOTAL VOLUME
"SMALL"	1.5 FT	1 FT	7.5 FT	0.5 CY
"LARGE"	3 FT	3 FT	7.5 FT	4 CY

1. 10/26/2024 NGH FINAL BID PLAN SET
 2. 10/26/2024 NGH FINAL BID PLAN SET
 3. 10/26/2024 NGH FINAL BID PLAN SET
 4. 10/26/2024 NGH FINAL BID PLAN SET
 5. 10/26/2024 NGH FINAL BID PLAN SET

NO	DATE	BY	REVISION
5			
4			
3			
2			
1			
0	10/26/2024	NGH	FINAL BID PLAN SET

ISSUE DATE	10/26/2024
DESIGN BY	EOR
DRAWN BY	NGH/BP
EOR PROJECT NO.	2028-0001

EOR Emmons & Olivier Resources, Inc.
 1334 DEWEY COURT
 MADISON, WI 53703
 ecology community
 Tel: 608.839.4422
 www.eorinc.com

WAUKESHA COUNTY
 WISCONSIN
 515 W. MORELAND BLVD.,
 WAUKESHA, WI 53188

ARPA STORMWATER MANAGEMENT PRACTICES

STREAM STABILIZATION DETAILS - 1

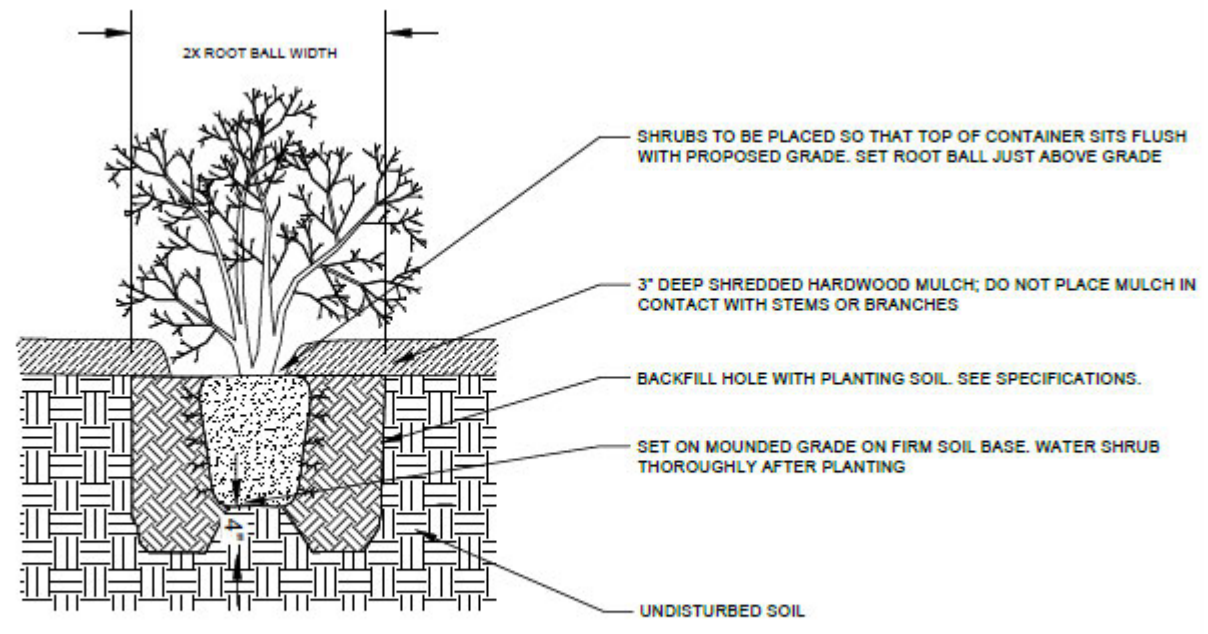

01 DECIDUOUS SHRUB PLANTING
34 NOT TO SCALE

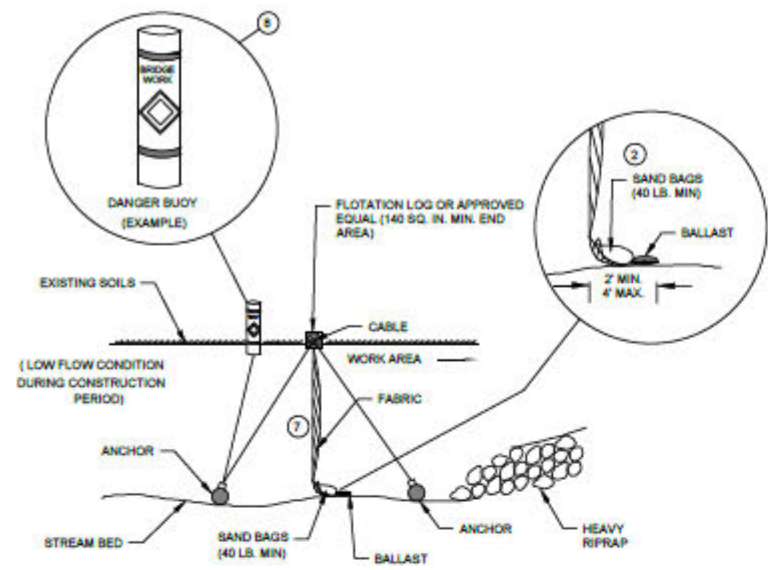

SECTION B - B

TURBIDITY BARRIER - FLOAT ALTERNATIVE
CAUTION - SEE NOTE 6

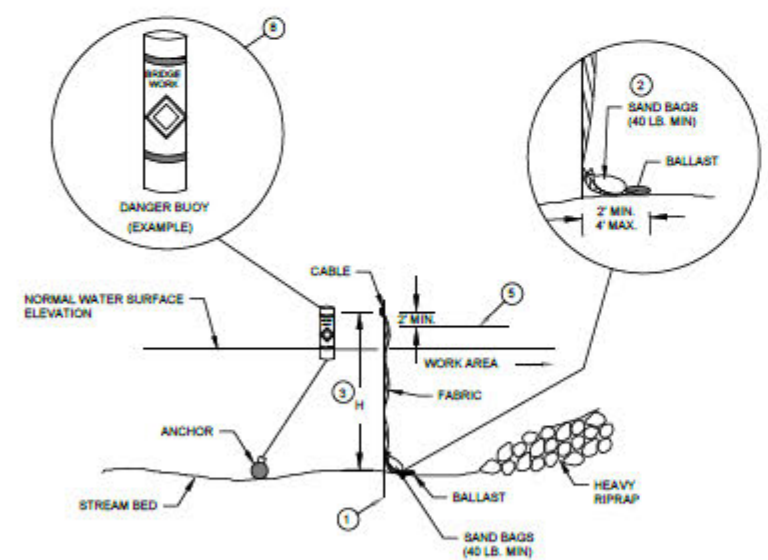

SECTION A - A

TURBIDITY BARRIER - STANDARD POST INSTALLATION

TURBIDITY BARRIER PLACEMENT DETAILS

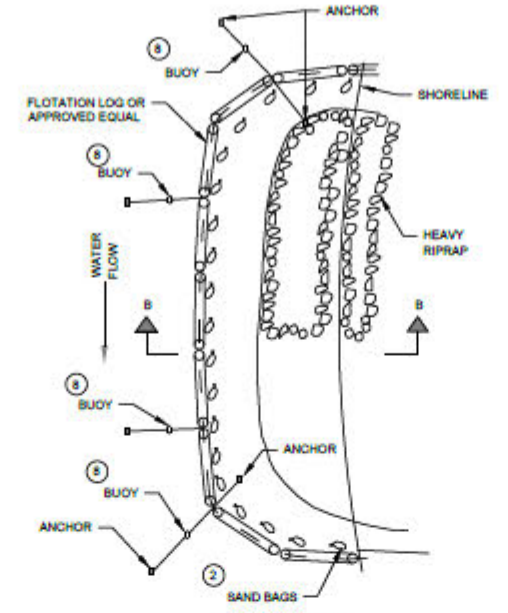

PLAN VIEW

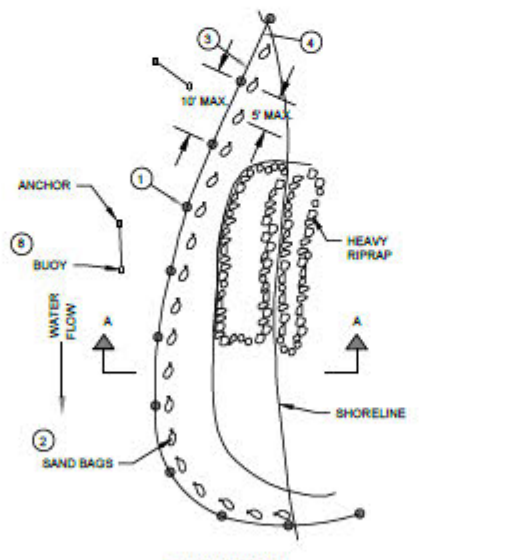

PLAN VIEW

GENERAL NOTES (TO BE UPDATED WITH PROJECT SPECIFICS)

DETAILS OF CONSTRUCTION, MATERIALS AND WORKMANSHIP NOT SHOWN ON THIS DRAWING SHALL CONFORM TO THE PERTINENT REQUIREMENTS OF THE STANDARD SPECIFICATIONS AND THE APPLICABLE SPECIAL PROVISIONS.
TURBIDITY BARRIER MAY BE REMOVED AT THE ENGINEERS DISCRETION, WHEN PERMANENT EROSION CONTROL MEASURES HAVE BEEN ESTABLISHED.

- 1 DRIVEN STEEL POSTS, PIPES, OR CHANNELS. LENGTH SHALL BE SUFFICIENT TO SECURELY SUPPORT BARRIER AT HIGH WATER ELEVATIONS.
- 2 SAND BAGS TO BE USED AS ADDITIONAL BALLAST WHEN ORDERED BY THE ENGINEER TO MEET ADVERSE FIELD CONDITIONS. SPACE AS APPROPRIATE FOR SITE CONDITIONS.
- 3 WHEN BARRIER HEIGHT "H" EXCEEDS 8 FEET, POST SPACING MAY NEED TO BE DECREASED.
- 4 IN WATERWAYS SUBJECT TO FLUCTUATING WATER ELEVATIONS, PROVISIONS SHOULD BE MADE TO ALLOW THE WATER TO EQUALIZE ON EACH SIDE OF THE BARRIER. THIS MAY BE ACCOMPLISHED BY LEAVING A PORTION OF THE BARRIER OPEN ON THE UPSTREAM END.
- 5 ESTIMATED HIGH WATER ELEVATION DURING CONSTRUCTION PERIOD. MINIMUM BARRIER HEIGHT SHALL BE 2' GREATER THAN EITHER THE Q2 ELEVATION OR THE ESTIMATED HIGH WATER ELEVATION DURING CONSTRUCTION, WHICHEVER IS GREATER.
- 6 FLOAT ALTERNATIVE WILL ONLY BE ALLOWED WITH WRITTEN APPROVAL OF THE ENGINEER, AND IS MEANT FOR LOCATIONS WHERE BEDROCK PREVENTS THE INSTALLATION OF POSTS.
- 7 ALLOW SUFFICIENT SLACK VERTICALLY AND HORIZONTALLY SO THAT SEDIMENT BUILD UP WILL NOT SEPARATE OR LOWER THE TURBIDITY BARRIER.
- 8 USE AS DIRECTED BY COAST GUARD OR DNR PERMIT WHEN WORKING IN NAVIGABLE WATERWAYS.

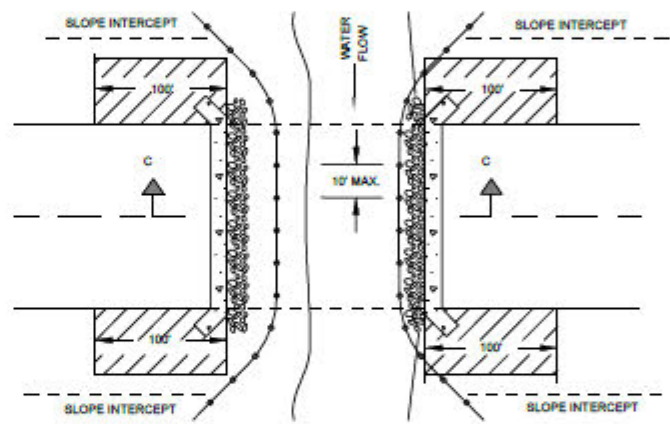

PLAN VIEW

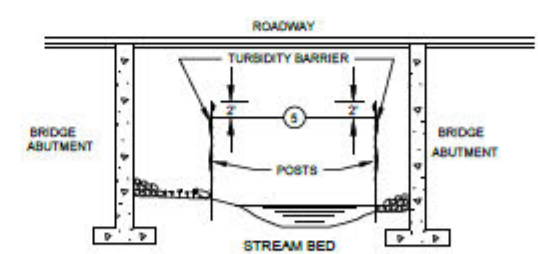

SECTION C - C

TURBIDITY BARRIER DETAIL SHOWING
TYPICAL PLACEMENT AT STRUCTURES

TURBIDITY BARRIER	
STATE OF WISCONSIN DEPARTMENT OF TRANSPORTATION	
APPROVED 6/4/02 DATE	/S/ Beth Cannestra CHIEF ROADWAY DEVELOPMENT ENGINEER

01 TURBIDITY BARRIER
38

NO	DATE	BY	REVISION
5			
4			
3			
2			
1			
0	10/06/2024	NGH	FINAL BID PLAN SET

ISSUE DATE: 10/06/2024
 DESIGN BY: EOR DRAWN BY: NGH/SP
 EOR PROJECT NO.: 2024-0001

EOR Emmons & Olivier Resources, Inc.
 1334 DEWEY COURT
 MADISON, WI 53703
 Tel: 608.839.4422
 www.eorinc.com

WAUKESHA COUNTY
 PLANNING AND LAND USE

515 W. MORELAND BLVD.,
 WAUKESHA, WI 53188

ARPA STORMWATER MANAGEMENT PRACTICES

BEST MANAGEMENT PRACTICES DETAILS - 3

Attachment #6

ATTACHMENT #6
TABLE OF CONTENTS

I.	Introduction _____	1
II.	Reach A _____	1
III.	Reach B _____	7
IV.	Reach C _____	13

I. Introduction

The lateral recession rate of the eroding bank is a critical component for the NRCS Streambank Erosion Estimator. The following documentation provides the justification for the lateral recession rates used in the NRCS Streambank Erosion Estimator. Lateral recession rate was estimated based on the photos provided, description, and on site evaluation. The following includes representative photos of Project Reaches to be stabilized through installation of Best Management Practices (BMPs).

II. Reach A



Image 1.1 – Bank on right, undercut with slumped sections in stream, covered with grass

III. Reach B



Image 2.1 – Bank, undercut with exposed roots and overgrown with grass.



Image 2.2 – Bank, undercut, on left.



Image 2.3 – Bank, undercut, on left.

IV. Reach C



Image 3.1 – Bank, undercut with slump, covered with grass.

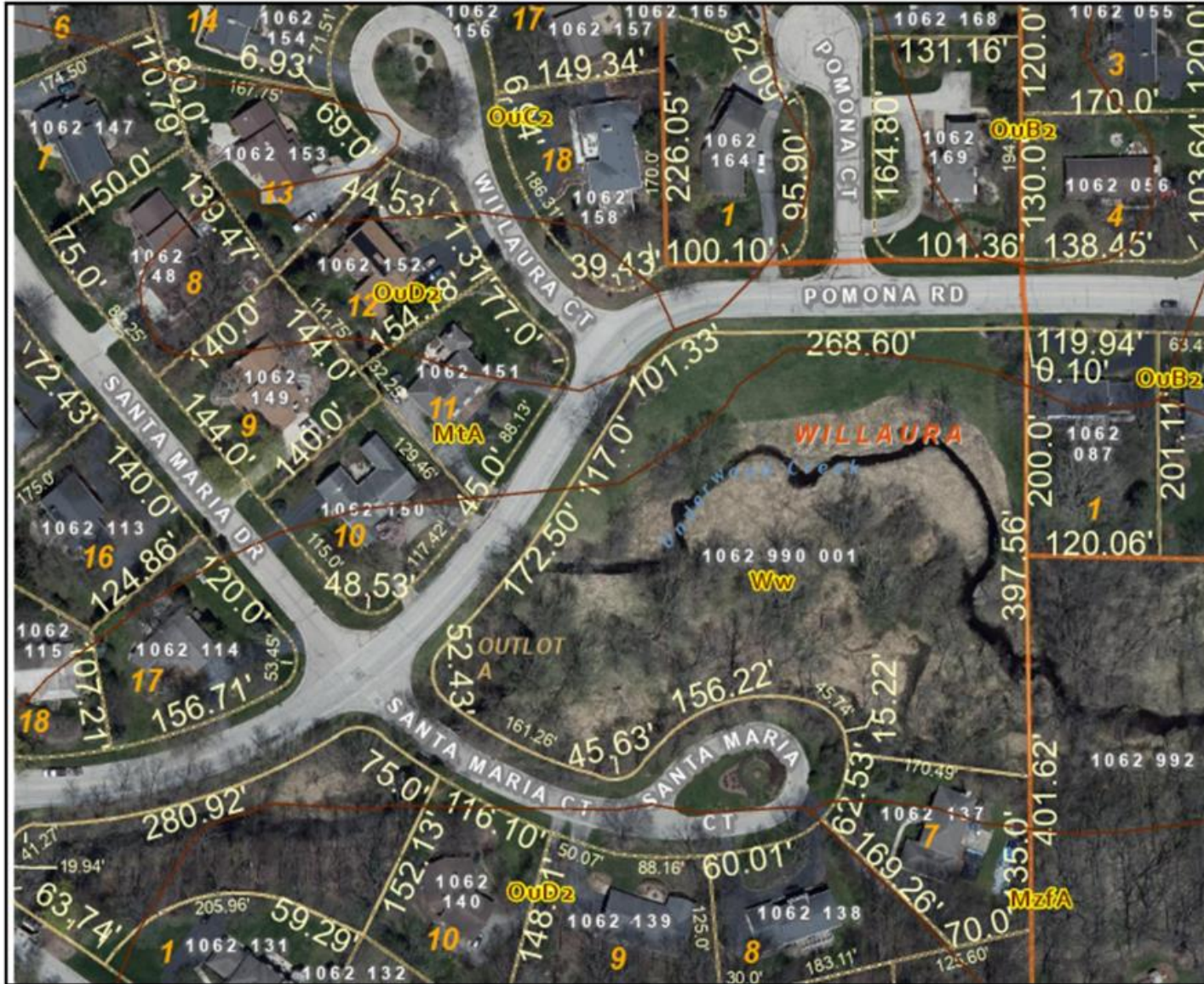

Image 3.2 – Bank on left, undercut with slump.



Image 3.3 – Bank on right, undercut with slumped material, covered with grass.

Attachment #7



- Legend**
- Soils
 - Municipal Boundary
 - Points of Interest
 - Parcel_Dimension_2K
 - Note_Text_2K
 - Lots_2K
 - Lot
 - Unit
 - General Common Element
 - Outlot
 - SimultaneousConveyance
 - Assessor Plat
 - CSM
 - Condominium
 - Subdivision
 - Cartoline_2K
 - EA-Easement_Line
 - PL-DA
 - PL-Extended_Tie_line
 - PL-Meander_Line
 - PL-Note
 - PL-Tie
 - PL-Tie_Line
 - <all other values>
 - Road Centerlines_2K
 - Railroad_2K
 - TaxParcel_2K
 - Waterbodies_2K_Labels
 - Waterlines_2K_Labels

0 137.55 Feet

The information and depictions herein are for informational purposes and Waukesha County specifically disclaims accuracy in this reproduction and specifically admonishes and advises that if specific and precise accuracy is required, the same should be determined by procurement of certified maps, surveys, plats, Flood Insurance Studies, or other official means. Waukesha County will not be responsible for any damages which result from third party use of the information and depictions herein, or for use which ignores this warning.

Notes:

Printed: 4/19/2024



Map Unit Legend

Map Unit Symbol	Map Unit Name	Acres in AOI	Percent of AOI
Am	Alluvial land	26.4	25.2%
CeB	Casco loam, 2 to 6 percent slopes	16.8	16.0%
Cv	Clayey land	0.1	0.1%
Lu	Loamy land	0.2	0.2%
MgA	Martinton silt loam, 1 to 3 percent slopes	11.0	10.5%
MtA	Mequon silt loam, 1 to 3 percent slopes	0.9	0.9%
OuB	Ozaukee silt loam, high carbonate substratum, 2 to 6 percent slopes	2.0	1.9%
OuB2	Ozaukee silt loam, high carbonate substratum, 2 to 6 percent slopes, eroded	38.6	36.8%
Sm	Sebewa silt loam, 0 to 2 percent slopes	9.0	8.6%
Totals for Area of Interest		104.9	100.0%



Soil and Forage Analysis Lab
 WISCONSIN STATE LABORATORY OF HYGIENE
 UNIVERSITY OF WISCONSIN-MADISON

4702 University Avenue
 Madison, WI 53705
 608-262-4364
soil-lab@mailplus.wisc.edu
<https://uwlab.soils.wisc.edu>

Marissa Castello
 515 W Moreland Blvd AC260
 Waukesha, WI 53188

Date 7/3/2023
Acct # 560726
Lab # 2544

Soil - Texture Analysis

Sample #	Sample ID	Sand %	Silt %	Clay %	Texture Name	Total P %
1	Underwood Creek Brookfield Strambank (1)	65	26	9	Sandy Loam	
2	Underwood Creek Brookfield Strambank (1)					0.07



Soil and Forage Analysis Lab
 WISCONSIN STATE LABORATORY OF HYGIENE
 UNIVERSITY OF WISCONSIN-MADISON

4702 University Avenue
 Madison, WI 53705
 608-262-4364
soil-lab@mailplus.wisc.edu
<https://uwlab.soils.wisc.edu>

Marissa Castello
 515 W Moreland Blvd AC260
 Waukesha, WI 53188

Date 7/3/2023
Acct # 560726
Lab # 2545

Soil - Texture Analysis

Sample #	Sample ID	Sand %	Silt %	Clay %	Texture Name	Total P %
1	Underwood Creek Brookfield Streambank (2)	53	34	13	Sandy Loam	
2	Underwood Creek Brookfield Streambank (2)					0.09



Marissa Castello
515 W Moreland Blvd AC260
Waukesha, WI 53188

Date 7/3/2023
Acct # 560726
Lab # 2546

Soil - Texture Analysis

Sample #	Sample ID	Sand %	Silt %	Clay %	Texture Name	Total P %
1	Underwood Creek Brookfield Streambank (3)	69	16	15	Sandy Loam	
2	Underwood Creek Brookfield Streambank (3)					0.06

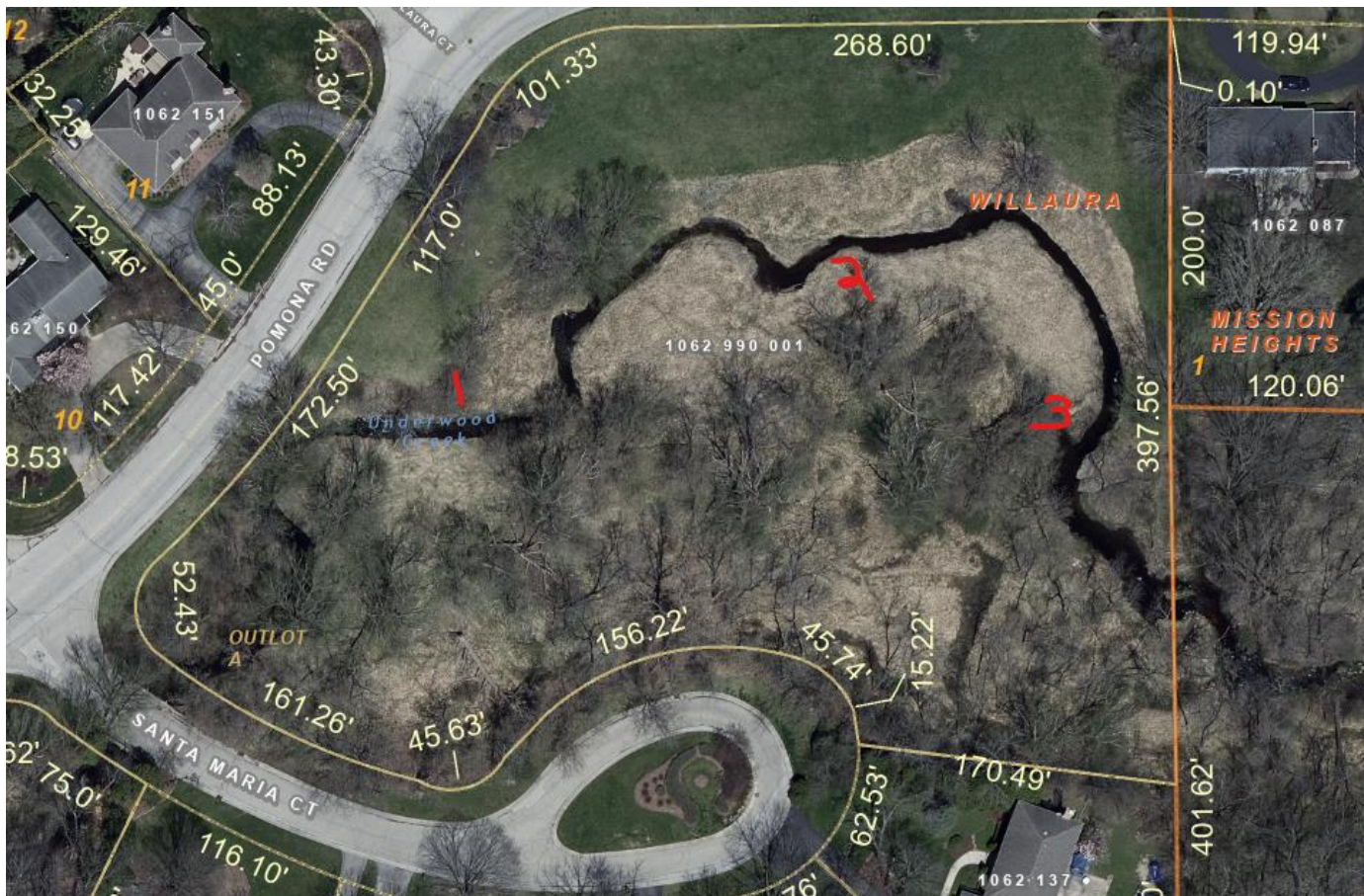

SOIL TOTAL P

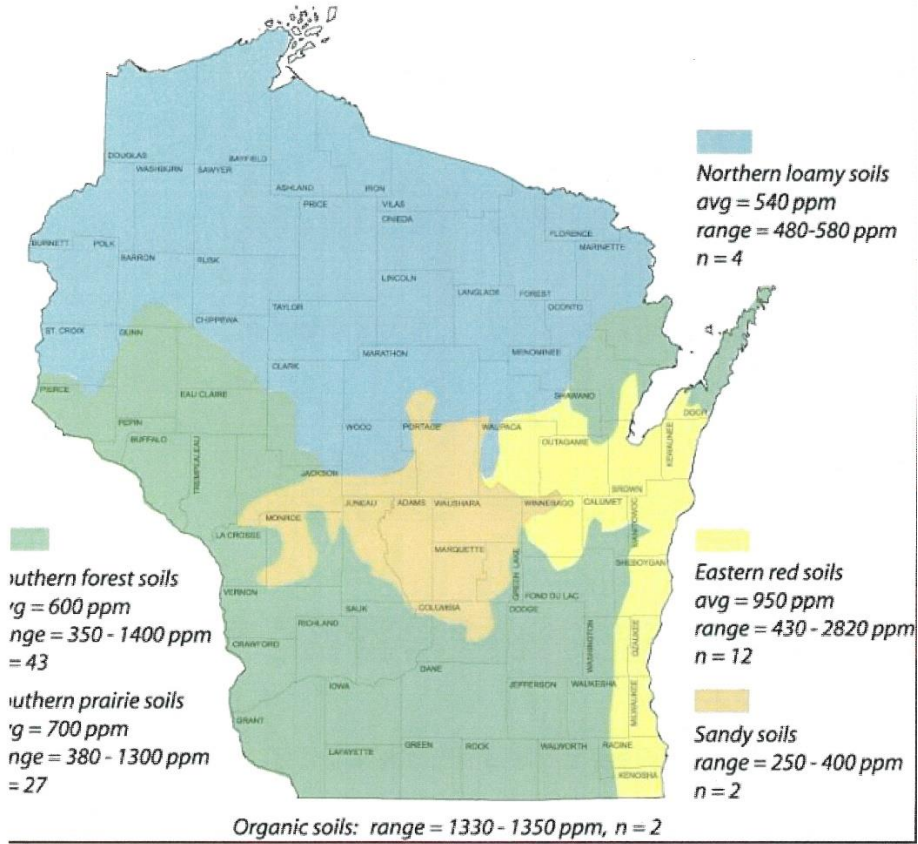

Attachment #8

Annual soil loss predictions for conservation planning purposes are made with current soil loss prediction technology (RUSLE2). RUSLE2 estimates sheet, rill and interrill erosion. Erosion that is seasonal in nature and caused by concentrated flow, however, is not predicted by RUSLE2.

This workbook provides conservation planners with simple tools and processes to help estimate the amount of erosion occurring in ephemeral gullies, classic gullies and on streambank erosion sites.

Definitions:

Rill Erosion: consists of the removal of soil by concentrated water running through little streamlets, or headcuts. Detachment in a rill occurs if the sediment in the flow is below the amount the load can transport and if the flow exceeds the soil's resistance to detachment. As detachment continues or flow increases, rills will become wider and deeper. Rills may be of any size but are usually less than four inches deep. Rills are:

- <> generally parallel on the slope, but may converge,
- <> generally of uniform spacing and dimension,
- <> generally appear at different locations on the landscape from year to year,
- <> generally shorter than ephemeral cropland gullies,
- <> usually end at a concentrated flow channel, or an area where the slope flattens and deposition occurs,
- <> are on the same portion of the slope that is used to determine the length of slope (L) for RUSLE2,
- <> many small, but conspicuous channels running in the direction of slope gradient

Rill erosion is considered in the RUSLE2 calculations.

Ephemeral Gully Erosion: Small erosion channels formed on crop fields as a result of concentrated flow of runoff water. These channels are routinely eliminated by tillage of the field but return following subsequent runoff events. Ephemeral Gullies are small enough to be eliminated (temporarily) with the use of typical farm tillage equipment and they:

- <> recur in the same area of concentrated flow each time they form,
- <> frequently form in well-defined depressions in natural drainage ways,
- <> are generally wider, deeper, and longer than the rills in the field,

Ephemeral Gullies are **not** calculated by the RUSLE2 program.

Gully Erosion: Permanent gullies are formed when channel development has progressed to the point where the gully is too wide and too deep to be tilled across. These channels carry large amounts of water after rains and deposit eroded material at the foot of the gully. They disfigure landscape and make the land unfit for growing crops. Gullies:

- <> may grow or enlarge from year to year by head cutting and lateral enlarging,
- <> often occur in depressions or natural drainage ways,
- <> may begin as ephemeral gullies that were left in the field untreated,
- <> may, over time, become partially stabilized by grass, weeds or woody vegetation,

Gully erosion is not calculated by the RUSLE2 program.

Streambank Erosion: The wearing away of streambanks by flowing water. The removal of soil from streambanks is typically caused by the direct action of stream flow and/or wind/wave action, typically occurring during periods of high flow. Streambank erosion:

<> is a natural process that generally increases when unprotected streambanks (e.g. no woody vegetation) are subject to the actions of flowing water and ice damage.

<> is a common occurrence on many Vermont river channels that are experiencing geomorphic adjustments

The soil loss from ephemeral gullies, gullies and streambank erosion areas can be estimated by calculating the volume of soil removed by erosion processes. The volume of soil loss can be multiplied by the typical unit weight of the soil (based on soil texture) which is eroded. Approximate soil unit weights are expressed below¹:

Soil Texture	Estimated Dry Density lb/ft ³
Gravel	110
Sand	105
Loamy Sand	100
Sandy Loam	100
Fine Sandy Loam	100
Sandy Clay Loam	90
Silt Loam	85
Silty Clay Loam	85
Silty Clay	85
Clay Loam	85
Organic	22

Procedure for estimating Ephemeral Soil Erosion:

The following formula will be used to calculate annual estimated ephemeral gully erosion:

$$\frac{\text{Ephemeral Gully Length} \times \text{Gully Average Width} \times \text{Gully Average Depth}}{2000} \times \text{Soil Weight (lbs/ft}^3\text{)} \times \text{Occurrences per Year} = \text{Estimated Soil Loss (Tons per Year)}$$

* Ephemeral gully erosion may reform multiple times per year, and under certain conditions it may not form in a given year. The voided volume which would be calculated after a runoff event is not necessarily representative of an annual rate, but is representative of only the specific event. This erosion can be calculated for individual storms and can be summed for a yearly estimate.

¹ Data from published soil surveys, laboratory data, and soil interpretation record are to be used where available. Parent materials, soil consistency, soil structure, pore space, soil texture, and coarse fragments all influence unit weight.

Procedure for estimating Gully Soil Erosion:

The following formula will be used to calculate annual estimated classic gully erosion:

$$\frac{\text{Gully Length} \times (\text{Average Width} \times \text{Average Depth} \times 0.5) \times \text{Soil Weight (lbs/ft}^3)}{2000} \div \text{Formation Years} = \text{Estimated Soil Loss Per Year (Tons)}$$

Procedure for estimating Streambank Soil Erosion (Direct Volume Method):

The following formula will be used to calculate annual estimated streambank erosion unless a field measurement procedure² is used:

$$\frac{\text{Eroding Bank Length} \times \text{Eroding Bank Height} \times \text{Lateral Recession Rate (FT/YR)} \times \text{Soil Weight (lb)}}{2000} = \text{Estimated Soil Loss Per Year (Tons)}$$

** Eroding bank height is measured along the bank, not the vertical height of bank. Example: if vertical height of an eroding streambank is 5 feet, and the bank is on a 2:1 slope, the total eroding bank distance is 25 feet -- 1/2 (Base X Height).

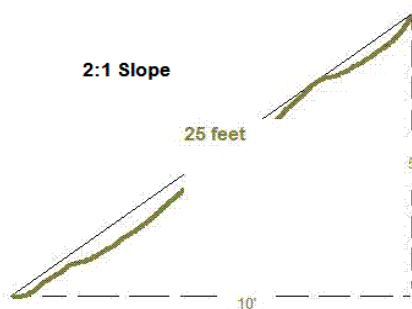

***The average annual recession rate is the thickness of soil eroded from a bank surface (perpendicular to the face) in an average year.

Stream bank erosion sometimes presents itself as a major occurrence in a given year, whereas the same bank may not erode significantly for a period of years if no major runoff events occur. Recession rates need to be calculated as an average of years when erosion does and does not occur. Recession rate is not calculated as the erosion occurring after a single event.

Use available resources to assist in the estimation of recession rate: use past and present aerial photography, old survey records, and any other information that helps to determine the bank condition at known times in the past. When such information is lacking or insufficient, field observations and professional judgement are needed to estimate recession rates.

It is often not possible to directly measure recession rates in the field. Therefore, the following table has been included which relates recession rates to narrative descriptions of banks eroding at different rates (Table from NRCS Wisconsin guidance).

Lateral Recession Rate (ft/yr)	Category	Description
0.01-0.05	Slight	Some bare bank but active erosion not readily apparent. Some rills but no vegetative overhang. No exposed tree roots.
0.06-0.2	Moderate	Bank is predominantly bare with some rills and vegetative overhang. Some exposed tree roots but no slumps or slips.
0.3-0.5	Severe	Bank is bare with rills and severe vegetative overhang. Many exposed tree roots and some fallen trees and slumps or slips. Some changes in cultural features such as fence corners missing and realignment of roads or trails. Channel cross section becomes U-shaped as opposed to V-shaped.
0.5+	Very Severe	Bank is bare with gullies and severe vegetative overhang. Many fallen trees, drains and culverts eroding out and changes in cultural features as above. Massive slips or washouts common. Channel cross section is U-shaped and stream course may be meandering.

2

The best way to quantify streambank erosion is to measure it directly in the field. The basic procedure in measuring streambank erosion is to survey, flag, or in some way fix a "before" image of the channel you are evaluating in order to establish the baseline condition. Changes due to erosion can then be monitored over time by going back to the study area and re-measuring from the fixed reference points.

Channel cross-sections can be surveyed and plotted on a periodic basis to monitor change. Stakes or pins can be driven into channel banks flush with the surface. The amount of stake or pin exposed due to erosion is the amount of change at the streambank erosion site between your times of observation.

The time required to monitor a site often precludes this method of data collection. The Direct Volume Method can be used to estimate streambank erosion at your site.

Acknowledgements: This Excel workbook was created as a planning tool for use by conservation planners. The basic format and content of the tool is a compilation of various similar tools, processes and procedures employed by NRCS in several states including: Indiana, Iowa, Kansas, Maryland, Michigan, Missouri, Nebraska, Oklahoma, South Dakota and Wisconsin. Some of the terminology in the 'Definitions' section of this Readme document closely mirrors these sources.

Bank Erosion Rate, Overlaid air photos, Reaches A, B, and C



I want to...

2024

Reach A

1062 990 001

2010

Underwood
Creek



2.92 ft
Total: 2.92 ft

5.47 ft
Total: 5.47 ft

7.76 ft
Total: 7.94 ft

12.15 ft
Total: 12.15 ft

12.47 ft
Total: 12.66 ft

4.47 ft
Total: 4.47 ft





Estimate of Bank Erosion Rate, 2010 to 2024

Reach A			Reach B			Reach C		
Station	Distance (ft)		Station	Distance (ft)		Station	Distance (ft)	
1	2.9		1	2.2		1	5.8	
2	5.5		2	4.4		2	2.1	
3	7.8		3	4.6		3	2.3	
4	12.2		4	6.4		4	2.2	
5	12.5		5	4.6		5	2.9	
6	4.5		6	4.7		6	3.5	
	ft	ft/yr		ft	ft/yr	7	5.7	
Average	7.6	0.54	Average	4.5	0.32		ft	ft/yr
Geomean	6.6	0.47	Geomean	4.3	0.31	Average	3.5	0.25
						Geomean	3.2	0.23

Soil Sample Summary

Sample	% Silt	% Clay	% Fines	TP ppm
A	26	9	35	700
B	34	13	47	900
C	16	15	31	600
		Ave	38	733
		Geomean	37	723

Total Suspended Solids Loss Estimate

NRCS Streambank Erosion Estimator (Direct Volume Method)								Clear Form			
Farmer / Cooperator Name:				City of Brookfield				Evaluated By:		Leif Hauge	
Tract Number:				Pomona Road park				Evaluation Date:		October 31, 2023	

Field Number	Eroding Streambank Reach Number	Eroding Bank Length (Feet)	Eroding Bank Height* (Feet)	Area of Eroding Streambank (FT ²)	Lateral Recession Rate (Estimated) (FT / Year)	Estimated Volume (FT ³) Eroded Annually	Soil Texture	Approximate Pounds of Soil per FT ³	Estimated Soil Loss (Tons/Year)
Brookfield Underwood Creek	Reach A	50.0	6.0	300	0.47	142.2	Sandy Loam	100	7.1
	Reach B	60.0	3.0	180	0.31	55.0	Sandy Loam	100	2.8
	Reach C	145.0	2.5	363	0.23	83.3	Sandy Loam	100	4.2
Total Estimated Annual Streambank Erosion Soil Loss (Tons):									14.0
Grand Total Estimated Annual Streambank Erosion Soil Loss (Tons):									14.0

* Eroding bank height is measured along the bank, not the vertical height of bank.

Streambank Erosion Calculation Formula:

$$\frac{\text{Eroding Bank Length} \times \text{Eroding Bank Height} \times \text{Lateral Recession Rate (FT/YR)} \times \text{Soil Weight (lbs/ft}^3\text{)}}{2000} = \text{Estimated Soil Loss Per Year (Tons)}$$

	Reach A	Reach B	Reach C	Totals
Soil sample % silt and cl	35	47	31	
TSS loss, lb/yr	4,977	2,587	2,582	10,146
TSS loss, lb/ 5 yrs	24,884	12,937	12,911	50,732

Total Phosphorus Loss Estimate

<i>Field Number</i>	<i>Eroding Streambank Reach Number</i>	<i>Estimated Soil Loss (Tons/Year)</i>	<i>Estimated Soil Loss (Pounds/Year)</i>	<i>Estimated Soil Loss (Kgs/Year)</i>	<i>Phosphorous Concentration (ppm)</i>	<i>Estimated Phosphorous Loss (Kgs/year)</i>	<i>Estimated Phosphorous Loss (Lbs/year)</i>
Pomona Rd, Underwood Creek	section A	7.1	14219	6463	700	4.5	10.0
	section B	2.8	5505	2502	900	2.3	5.0
	section C	4.2	8330	3786	600	2.3	5.0
		0.0	0	0		0.0	0.0
		0.0	0	0		0.0	0.0
		0.0	0	0		0.0	0.0
		0.0	0	0		0.0	0.0
		0.0	0	0		0.0	0.0
Total Estimated Annual Phosphorous Loss (Lbs):							19.9
Grand Total Estimated Annual Phosphorous Loss (Lbs):							19.9
TP loss / 5 yr:							100

Attachment #9

Water Quality Trading Operation and Maintenance Plan

Introduction:

The Water Quality Trading (WQT) Operation and Maintenance (O&M) Plan is meant to be a working document and should be updated as new trading practices are implemented. Currently, the Operation and Maintenance Plan revolves around streambank stabilization along Underwood Creek. The attached *Streambank Inspection Form* should be completed during annual inspections and following major storm events. Inspection forms shall be retained for at least five (5) years to ensure compliance with the WQT Plan.

Publicly Owned Riprap or Toe Wood:

County representative to complete inspection form annually and following major storm events. The form will then be provided to the Director of Public Works following inspection. The City will address maintenance issues identified during inspection within 30 days. Substantial maintenance issues may require an extended timeframe for generation of plans, specifications, and a public bid process to perform the work. Inspections and O&M activities shall be reported in the annual WQT Report sent to the DNR.

Easement:

A temporary construction easement and permanent access easement are to be utilized by the County of to construct the streambank stabilization.

Quality Assurance:

Riprap gradation and composition shall be provided for each source of material. Riprap shall be installed per *Wisconsin Department of Transportation Specification 606 Riprap*, attached.

Installation:

- Install erosion control.
- Grade streambanks as indicated on Plans.
- Install riprap:
 - Place geotextile fabric over substrate, lap edges and ends.
 - Do not place riprap over frozen or spongy subgrade surfaces.
 - Place riprap as indicated on Construction Plans.
 - Installed Thickness: Heavy Riprap; 18-inch to 24-inch diameter; installed minimum 30-inch thickness or as per thickness shown on the plans.
- Restore all disturbed areas to prevent erosion.

Practice Registration:

The purpose of the “Water Quality Trading Management Practice Registration” form is to report to WDNR that a management practice identified in the trading plan has been properly installed and is established and effective. This information will be used to track implementation progress, verify compliance and perform audits, as necessary. A registration form should be submitted for every management practice that has been identified in the trading plan. If practices are established prior to trading plan submittal, registration forms may be submitted with the trading plan. Otherwise, registration forms should be submitted during the permit term as practices become effective or with the annual report. A blank *Water Quality Trading Management Practice Registration Form 3400-207* is attached and should be submitted following implementation of the trading practice.

Tracking Procedures:

The County will track credits used monthly. The County will report credit usage to the DNR on a monthly basis in the Discharge Monitoring Reports (DMRs). The annual report will summarize the 12 months of credit usage and credit generation. The County will report to DNR any concern that they have that may result in a need to modify the trade agreement and/or this trade plan. For example, a need to generate additional credits based on discharge.

Inspections/Maintenance Considerations:

- A *Streambank Inspection Form* is attached.
 - Station: As noted on Construction Plans
 - Condition of toe wood or riprap: Excellent; Good; Fair; or Poor
 - Maintenance Estimate: Provide an estimate for how long the maintenance will take to complete or a dollar value for completion. This will help determine if the City will perform the work or if the City will hire another entity to perform the work.
 - Date Completed: Following completion of the required maintenance, input the date of completion.
 - Comments: Provide the required maintenance activity along with any other useful information. If the cell provided is not large enough for Comments, write “See Back of Sheet” and provide comments on the reverse side of the Form.
- Following installation of the toe wood or riprap, inspect the toe wood or riprap closely over the next few months to ensure that seeding grows.
- Toe wood or riprap may settle or shift especially after flooding events or freeze/thaw.
- May need to control weed and brush growth.
- Inspect toe wood or riprap areas as needed.
- At a minimum, inspect after major storm events.
- If toe wood or riprap has been damaged, repair it promptly to prevent a progressive failure.
- If repairs are needed repeatedly at a location, evaluate the site to determine if the original design conditions have changed.

Routine Maintenance Items that can be performed by City:

- Evaluate streambank condition (County inspector)
 - Re-grade/re-seed streambank that is impaired.
 - Reconstruct/replace toe wood or riprap that has settled, shifted, or washed out.

Routine Maintenance Items to be performed by the City of Brookfield

- Manage Vegetation
 - Remove invasive/noxious plants.

- Manage Garbage
 - Remove garbage and other debris that could otherwise impair the streambank stability.

Annual Certification:

Each year, the County will certify that the toe wood or riprap is maintained and operating in a manner consistent with this Water Quality Trading Plan or provide a statement noting noncompliance with this Plan. The annual Monitoring Report (AMR) will include the following statement as a certification of compliance when the Credit Generating Practice is operating in a manner consistent with the Plan:

“I certify that to the best of my knowledge that the management practices identified in the approved water quality trading plan as the source of phosphorus and total suspended solids credits is installed, established and properly maintained.”

Annual Inspection:

An annual inspection of the toe wood or riprap will be performed by a licensed Professional Engineer to ensure that the toe wood or riprap is functioning as intended in order to meet the requirements of the WQT Plan.

Noncompliance:

The County will notify DNR by telephone call to DNR’s regional wastewater compliance engineer within 24 hours or next business day of becoming aware that phosphorus and total suspended solids credits used or intended for use by County are not being generated as outlined in this Water Quality Trading Plan.

The County will submit a written notification within five days after the County recognizes that the phosphorus credits are not being generated as outlined in the Trading Plan. DNR may waive the requirement for submittal for a written notice within five days and instruct the County to submit the written notice with the next regularly scheduled monitoring report required by County’s WPDES Permit.

The written notification should include:

- Description of noncompliance and cause.
- Period of noncompliance including dates and times.
- Schedule for attaining compliance including time and steps toward compliance.
- Plan to prevent reoccurrence of the noncompliance.

Notification of Trade Agreement Termination:

If a trade agreement or the trading plan needs to be terminated during the permit term, the permittee should submit a Notice of Termination to the stormwater engineer/specialist to inform WDNR of the termination. WDNR staff should use this information to determine if a permit modification is required due to the termination, the termination will result in non-compliance, or other permit actions are required due to the termination. When credits are reduced or eliminated for any reason, the permittee is still required to meet their WQBELs without any grace period. To prevent noncompliance with WQBELs, changes to trading plans must be addressed before credits are lost. Modifying the permit/trading plan will require at least 180 days. A blank *Notification of Water Trade Agreement Termination Form 3400-209* is attached and should be submitted to WDNR prior to practice termination, no later than the submittal date of the annual report.

Streambank Inspection Form

Date _____

Inspector _____

Reason for Inspection _____

Stream Reach	Station Start	Station Stop	Condition	Required Maintenance	Maintenance Estimate (Time or Cost)	Date Completed	Comments
1							
2							
3							
4							
5							
6							
7							
8							
9							

Section 606 Riprap

606.1 Description

- (1) This section describes furnishing and placing riprap.

606.2 Materials

606.2.1 Riprap Stone

- (1) Furnish durable field or quarry stone that is sound, hard, dense, resistant to the action of air and water, and free of seams, cracks, or other structural defects. Use stone pieces with a length and width no more than twice the thickness. Do not place material without the engineer's approval of the stone quality, size, and shape.
- (2) The department will determine the average dimension of stone pieces by averaging measurements of thickness, width, and length. Furnish stones conforming to the size requirements for the riprap grade the plans show. Size requirements are expressed as the percent of the gross in-place riprap volume occupied by stones within average dimension size ranges for each riprap grade as follows:

AVERAGE DIMENSION RANGES FOR EACH RIPRAP GRADE				FRACTION OF GROSS
LIGHT	MEDIUM	HEAVY	EXTRA-HEAVY	IN-PLACE RIPRAP
RIPRAP	RIPRAP	RIPRAP	RIPRAP	VOLUME OCCUPIED
inches	inches	inches	inches	BY STONES
>16	>20	>25	>30	0%
11 - 13	14 - 16	18 - 20	22 - 25	10% - 14%
9 - 11	11 - 14	14 - 18	18 - 22	15% - 21%
4 - 9	5 - 11	6.5 - 14	8 - 18	20% - 28%
<4	<5	<6.5	<8	5% - 7%
<1	<1	<1	<1	2% or less

- (3) The contractor may substitute waste concrete slabs for stone. Furnish sound concrete, free of protruding reinforcement, and conforming to the size requirements specified for stone.

606.2.2 Riprap Grout

- (1) Furnish an air-entrained mortar or concrete to fill the voids between riprap stones in grouted riprap. Conform to the physical requirements for component materials as specified in [501.2](#) except furnish fine aggregate or a combination of fine and coarse aggregate with a gradation that results in a grout with a consistency that allows complete filling of the riprap voids.
- (2) Certify that the grout conforms to the following mixture requirements:
 - Contains 470 pounds or more of portland cement per cubic yard of grout. The contractor may substitute class C fly ash for up to 30 percent of the required portland cement.
 - Contains only enough water to achieve a 3-inch slump. Any additional workability required to completely fill the riprap voids must be achieved with admixture without increasing the w/cm ratio.
 - Contains 9 percent or more air for mixes with a nominal top size aggregate less than 3/8 inch or 7 percent or more air for a mix with 3/8 inch or larger aggregate.

606.3 Construction

606.3.1 General

- (1) Prepare the bed for the riprap by excavating, shaping the slopes, and constructing the toe for riprap installation. After placing the riprap, restore the surface of adjacent work and dispose of surplus material.

606.3.2 Placing Light Riprap

- (1) If laying stone above the waterline, place it by hand. Lay it with close, broken joints and firmly bed it in the slope and against the adjoining stones. Lay the stones perpendicular to the slope with ends in contact. Compact the riprap thoroughly as construction progresses. Make the finished surface even and tight. Place larger stone in lower courses. Chink spaces between stones by firmly ramming spalls into place. If placing riprap over geotextile, use type R and conform to [645.3.1.6](#).
- (2) Unless specified otherwise, make riprap at least one foot thick, measured perpendicular to the slope.
- (3) Do not place riprap against, or in contact with, concrete surface before the end of the concrete's curing and protection period.

606.3.3 Placing Medium, Heavy, and Extra-Heavy Riprap

- (1) The contractor may place medium, heavy, and extra-heavy riprap by any mechanical means that produce a completed job within reasonable tolerances of the typical section the plans show. Limit

handwork to the quantity necessary to fill large voids or to correct segregated areas. If placing riprap over geotextile, use type HR and conform to [645.3.1.7](#).

- (2) Unless specified otherwise, make medium riprap at least 18 inches thick, heavy riprap at least 24 inches thick, and extra-heavy riprap at least 30 inches thick.

606.3.4 Placing Grouted Riprap

- (1) If the plans specify using grouted riprap, lay the stone as specified above under [606.3.2](#) or [606.3.3](#). Fill the spaces between the stones with cement mortar. Use sufficient mortar or concrete to completely fill voids, except leave the face surface of the stone exposed.
- (2) Place grout from the bottom to the top and then sweep the surface with a stiff broom. After completing the grouting, cure the surface as specified in [415.3.12](#) except substitute type 1-D curing compound as specified for structures in [502.2.6](#). During cold weather, protect the concrete as specified in [415.3.13](#) for concrete pavement.

606.4 Measurement

- (1) The department will measure the bid items under this section by the cubic yard acceptably completed, measured as the volume within the limiting dimensions the contract designates or the engineer establishes in the field.

606.5 Payment

- (1) The department will pay for measured quantities at the contract unit price under the following bid items:

<u>ITEM NUMBER</u>	<u>DESCRIPTION</u>	<u>UNIT</u>
606.0100	Riprap Light	CY
606.0200	Riprap Medium	CY
606.0300	Riprap Heavy	CY
606.0400	Riprap Extra-Heavy	CY
606.0500	Grouted Riprap Light	CY
606.0600	Grouted Riprap Medium	CY
606.0700	Grouted Riprap Heavy	CY
606.0800	Grouted Riprap Extra-Heavy	CY

- (2) Payment for the bid items under this section is full compensation for preparing the bed, providing and placing riprap, restoring adjacent work, and disposing of surplus material. The department will pay for excavation in excess of the approximate volume of earth occupied by the riprap under the Excavation Common bid item as specified under [205.5](#).
- (3) Payment for the Grouted Riprap bid items also includes placing and curing mortar

**Water Quality Trading Management
 Practice Registration**
 Form 3400-207 (R 1/14)

Notice: Pursuant to s. 283.84, Wis. Stats., this form must be completed by any WPDES permittee that is using water quality trading as a method of complying with a permit limitation. Failure to complete this form would not result in penalties. Personal information collected will be used for administrative purposes and may be provided to requesters to the extent required by Wisconsin's Open Records Law (ss. 19.31 - 19.39, Wis. Stats.).

Applicant Information				
Permittee Name		Permit Number	Facility Site Number	
		WI-		
Facility Address			City	State ZIP Code
Project Contact Name (if applicable)	Address		City	State ZIP Code
Project Name				

Broker/Exchange Information (if applicable)	
Was a broker/exchange be used to facilitate trade? <input type="radio"/> Yes	
<input type="radio"/> No	

Broker/Exchange Organization Name	Contact Name	
Address	Phone Number	Email

Trade Registration Information (Use a separate form for each trade agreement)					
Type	Trade Agreement Number	Practices Used to Generate Credits	Anticipated Load Reduction	Trade Ratio	Method of Quantification
<input type="radio"/> Urban NPS <input type="radio"/> Agricultural NPS <input type="radio"/> Other					
County	Closest Receiving Water Name	Land Parcel ID(s)		Parameter(s) being traded	

The preparer certifies all of the following:

- I have completed this document to the best of my knowledge and have not excluded pertinent information.
- I certify that the information in this document is true to the best of my knowledge.

Signature of Preparer	Date Signed

Authorized Representative Signature	
I certify under penalty of law that this document and all attachments were prepared under my direction or supervision. Based on my inquiry of those persons directly responsible for gathering and entering the information, the information is, to the best of my knowledge and belief, accurate and complete. I am aware that there are significant penalties for submitting false information, including the possibility of fine and imprisonment for knowing violations.	
Signature of Authorized Representative	Date Signed

Leave Blank – For Department Use Only		
Date Received	Trade Docket Number	
Entered in Tracking System <input type="checkbox"/> Yes	Date Entered	Name of Department Reviewer

